

180-19-000-00
ΓΩΝΙΑ ΕΠΙΠΕΔΟΤΗΤΑΣ / ALIGNMENT CORNER

180-15-006-00
ΓΩΝΙΑ ΕΠΙΠΕΔΟΤΗΤΑΣ / ALIGNMENT CORNER

290-00-005-00
ΤΑΚΑΚΙ ΤΖΑΜΙΟΥ / GLAZING WEDGE

110-23-400-00
ΓΩΝΙΑ ΣΥΝΔΕΣΗΣ ΠΡΕΣΑΡΙΣΤΗ / PRESS CORNER

180-15-004-00
ΓΩΝΙΑ ΕΠΙΠΕΔΟΤΗΤΑΣ / ALIGNMENT CORNER

210-15-000-00
ΛΑΣΤΙΚΟ ΚΕΝΤΡΙΚΟ / CENTRAL GASKET

310-11-501-00
ΝΕΡΟΧΥΤΗΣ / WATER CAP

180-15-026-00
ΓΩΝΙΑ ΕΠΙΠΕΔΟΤΗΤΑΣ / ALIGNMENT CORNER

110-23-554-00
ΓΩΝΙΑ ΣΥΝΔΕΣΗΣ ΠΡΕΣΑΡΙΣΤΗ / PRESS CORNER

180-11-118-00
ΓΩΝΙΑ ΕΠΙΠΕΔΟΤΗΤΑΣ / ALIGNMENT CORNER

220-11-002-00
ΛΑΣΤΙΚΟ ΦΥΛΛΟΥ / GASKET

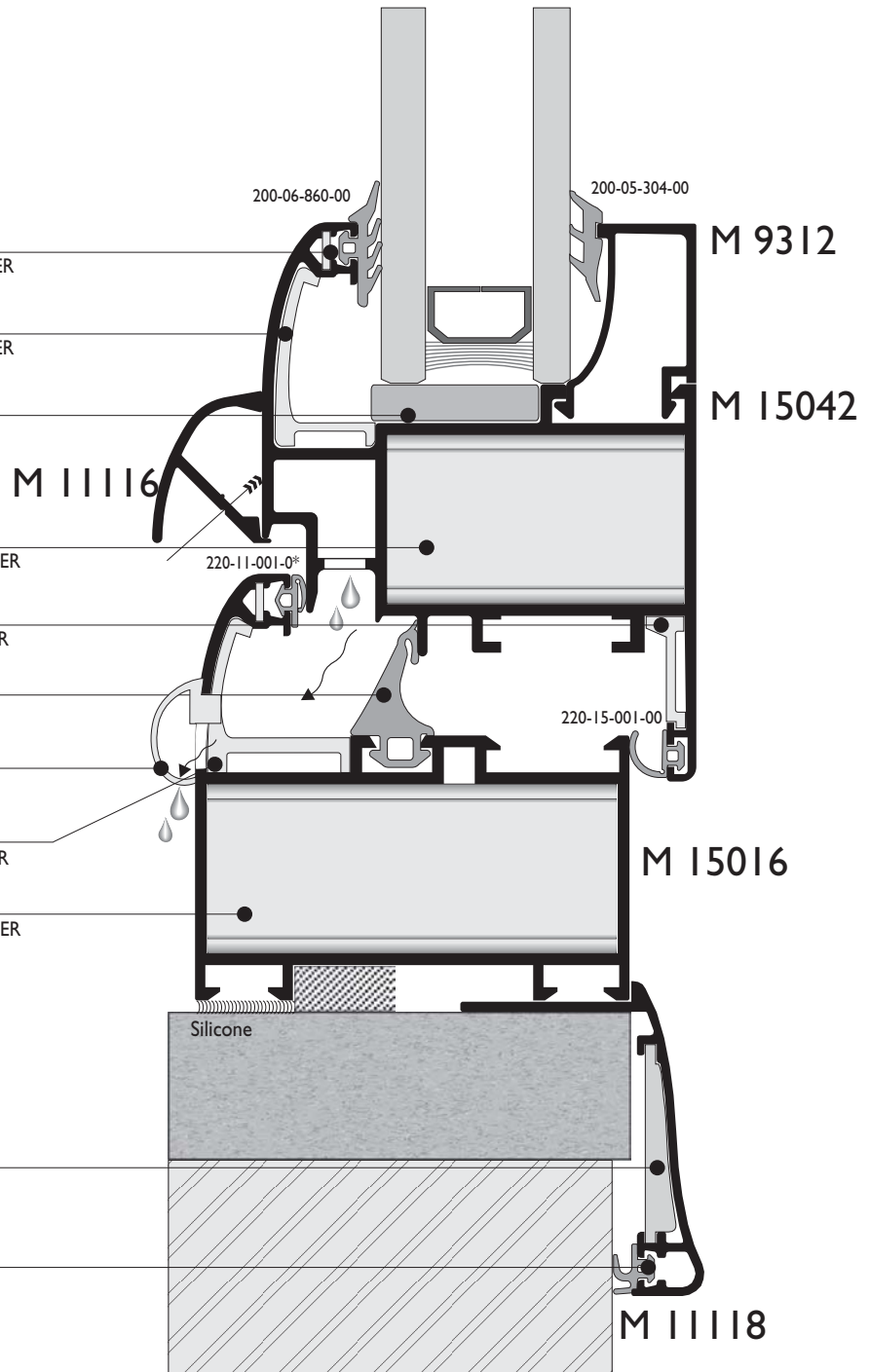

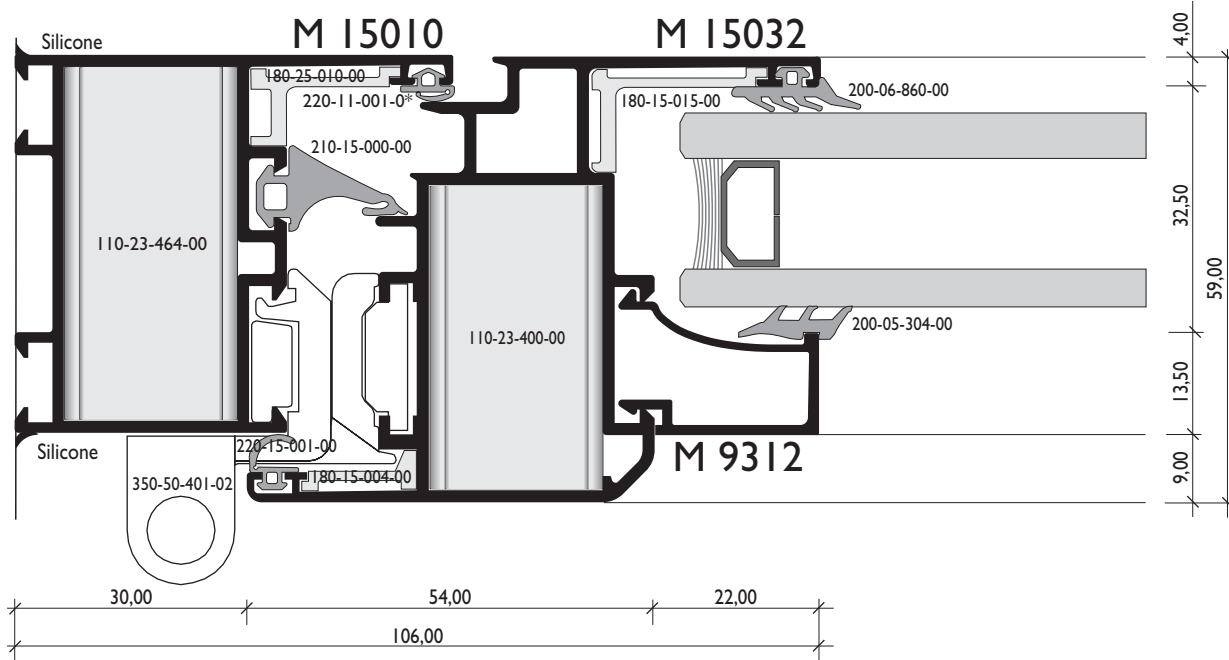
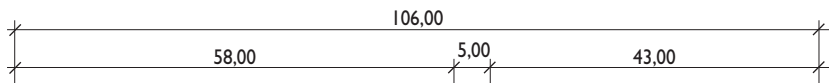
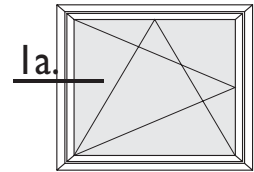
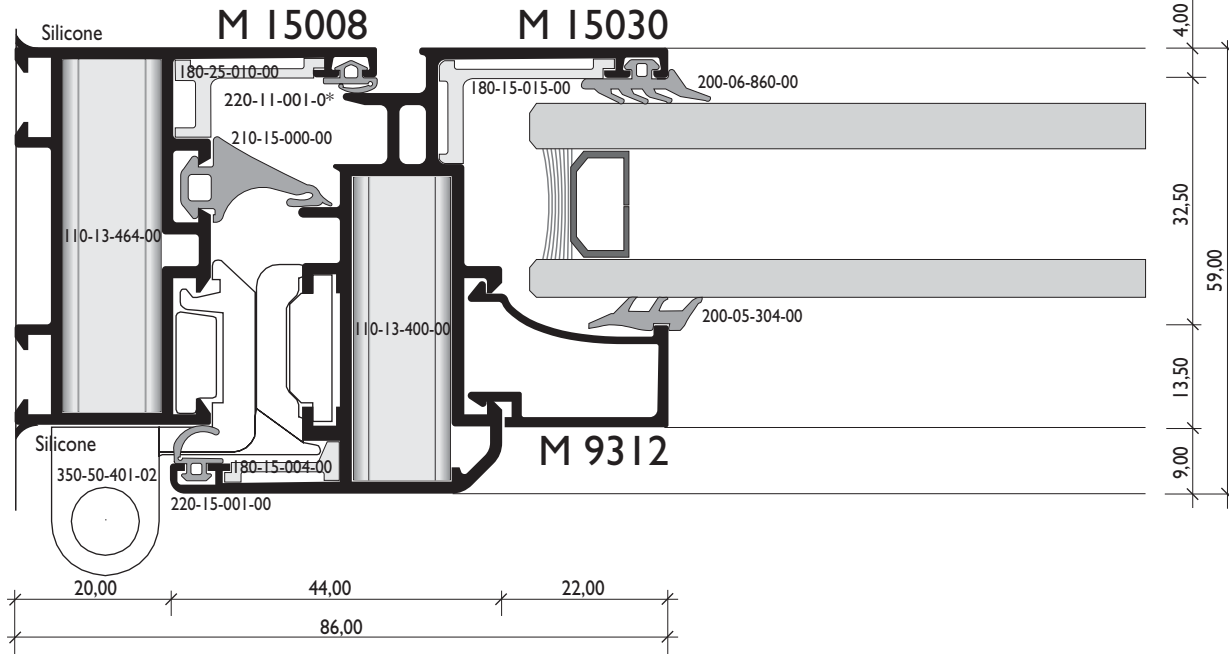
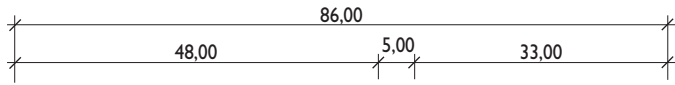
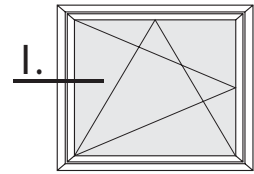

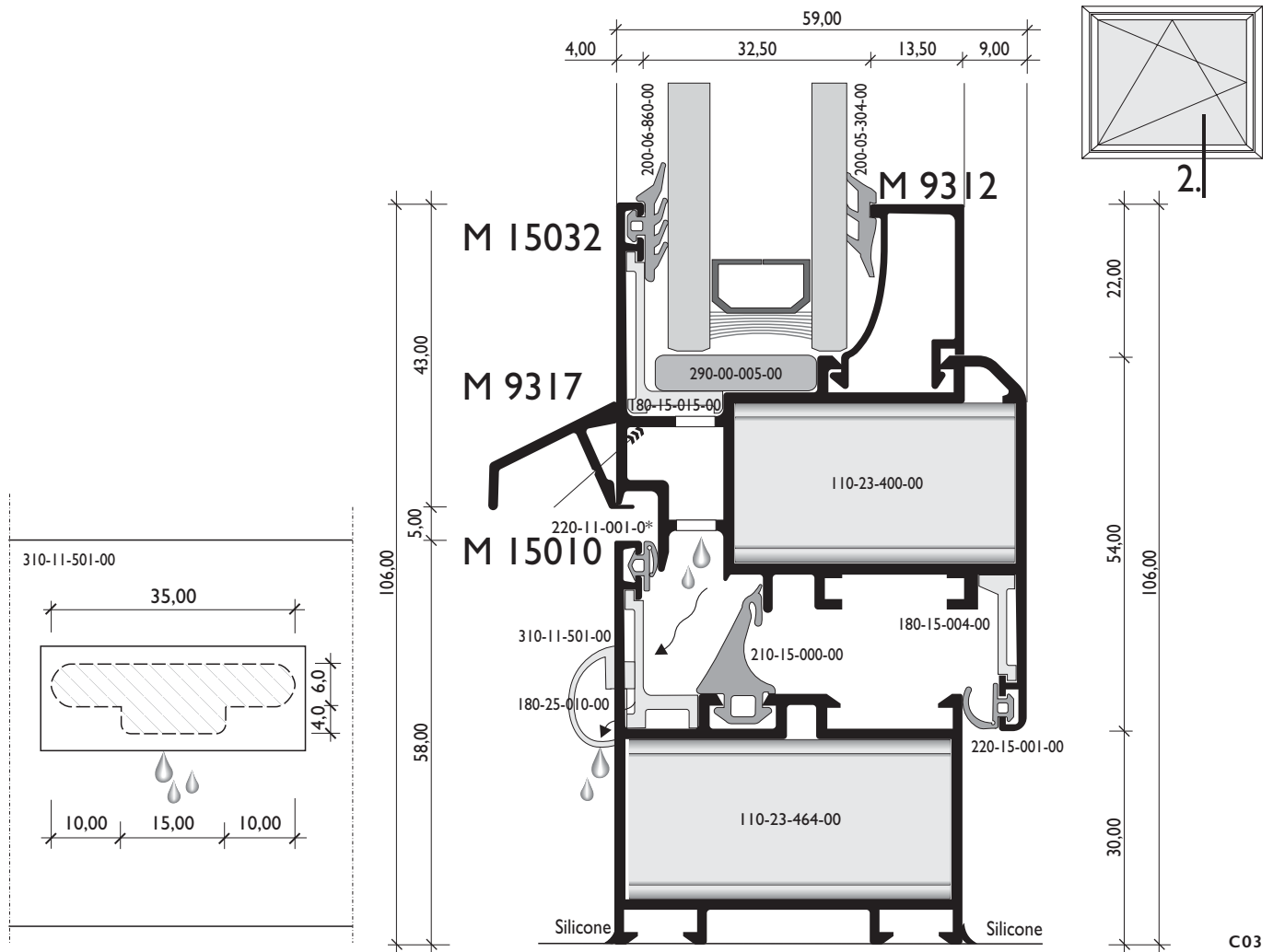
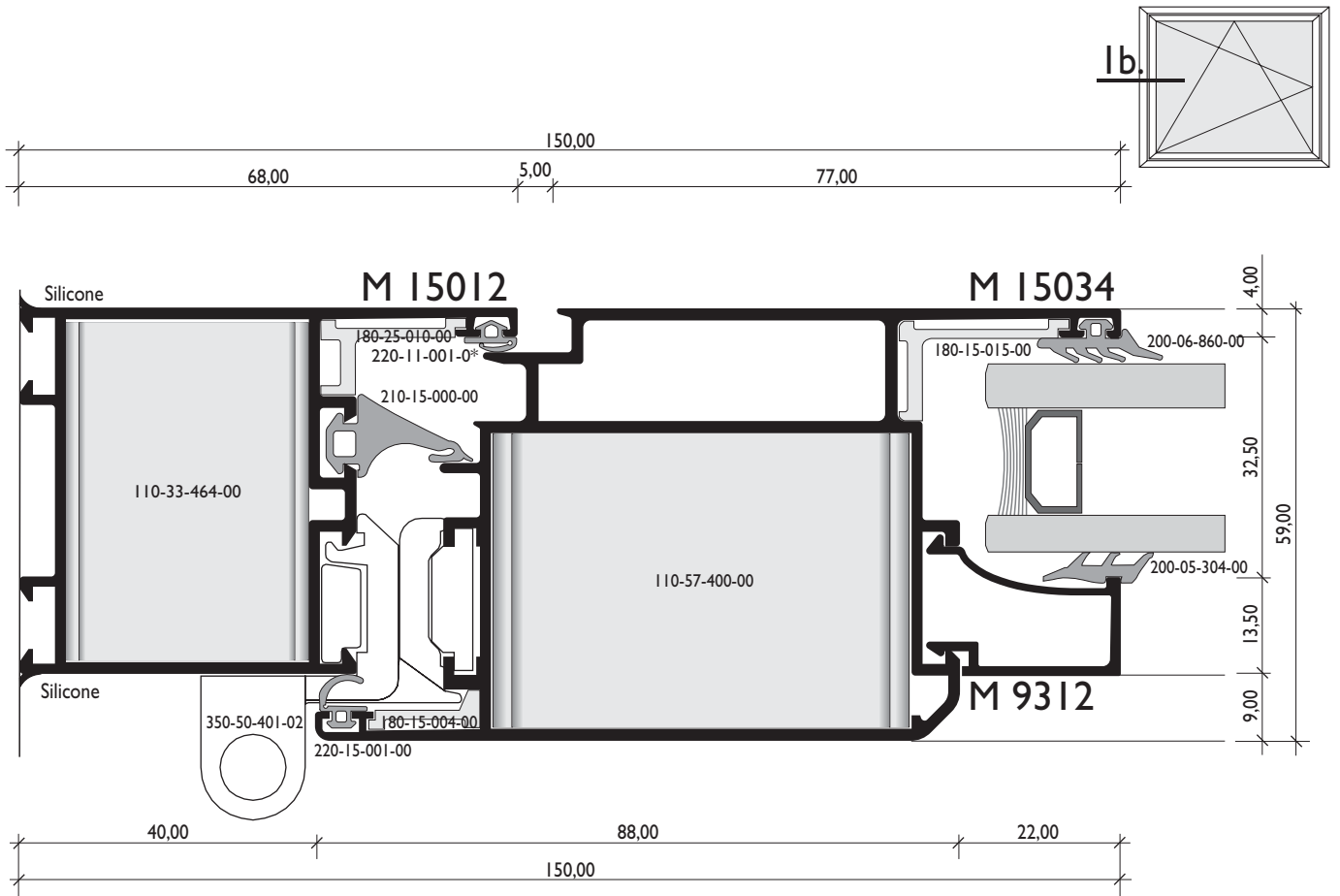

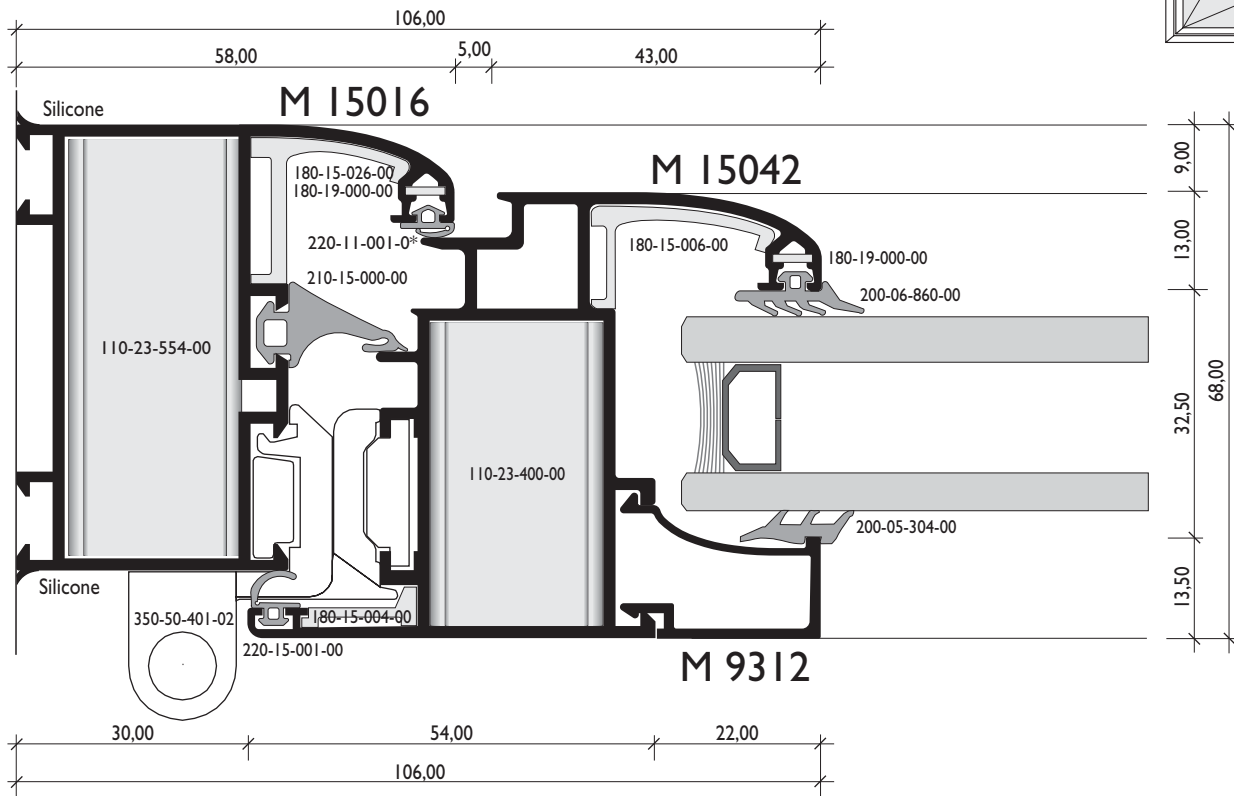
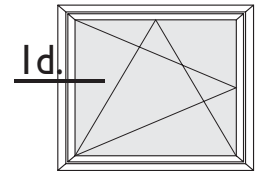
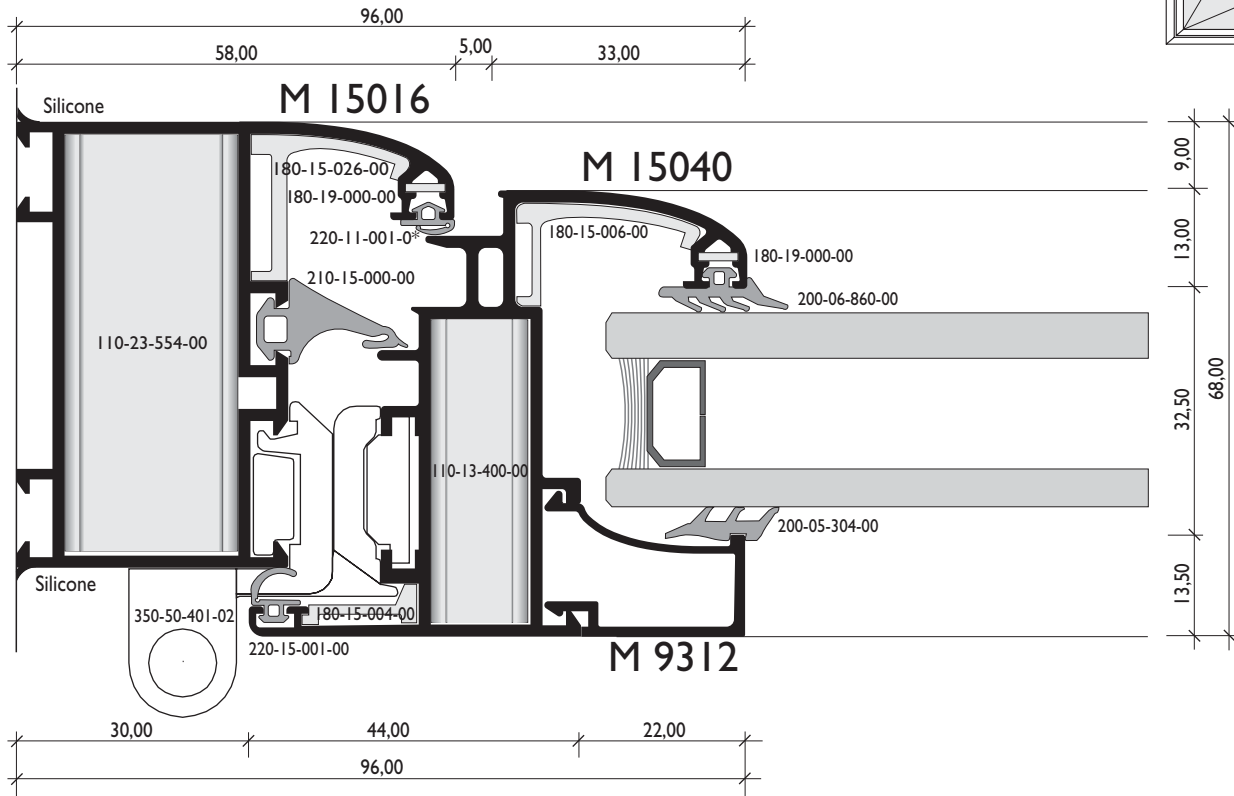
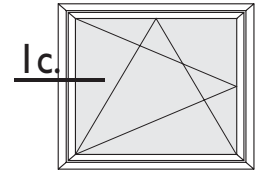

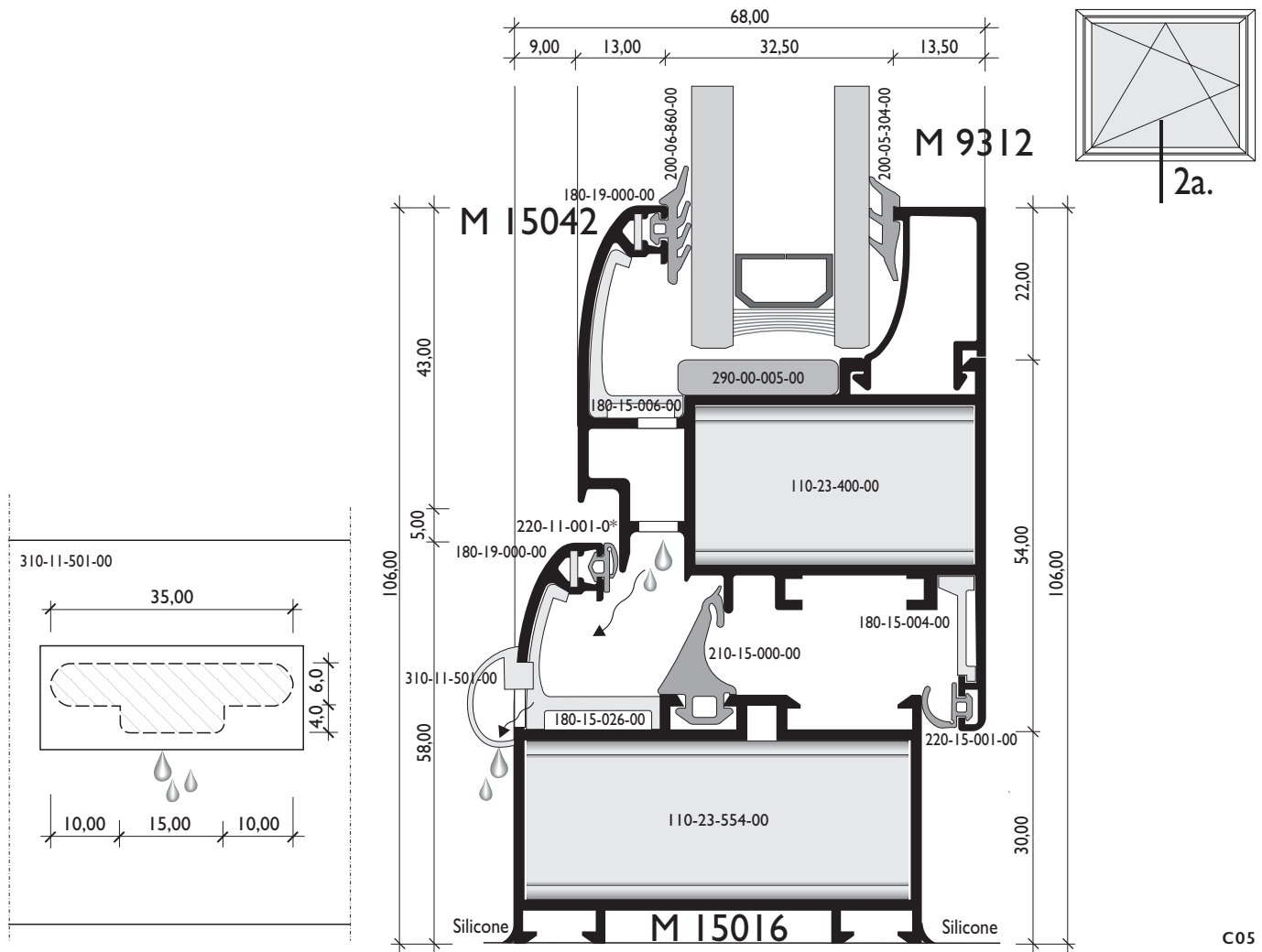
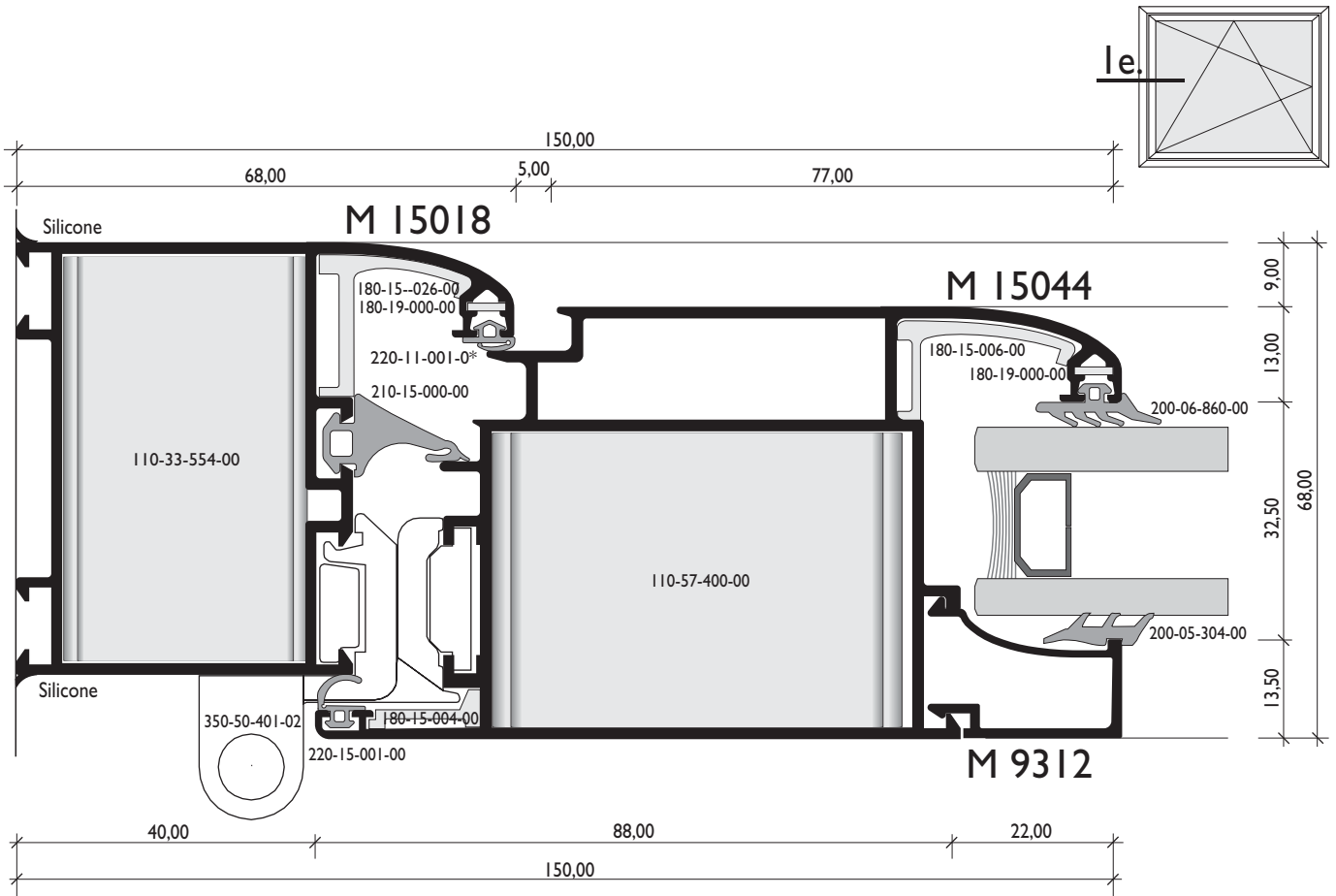

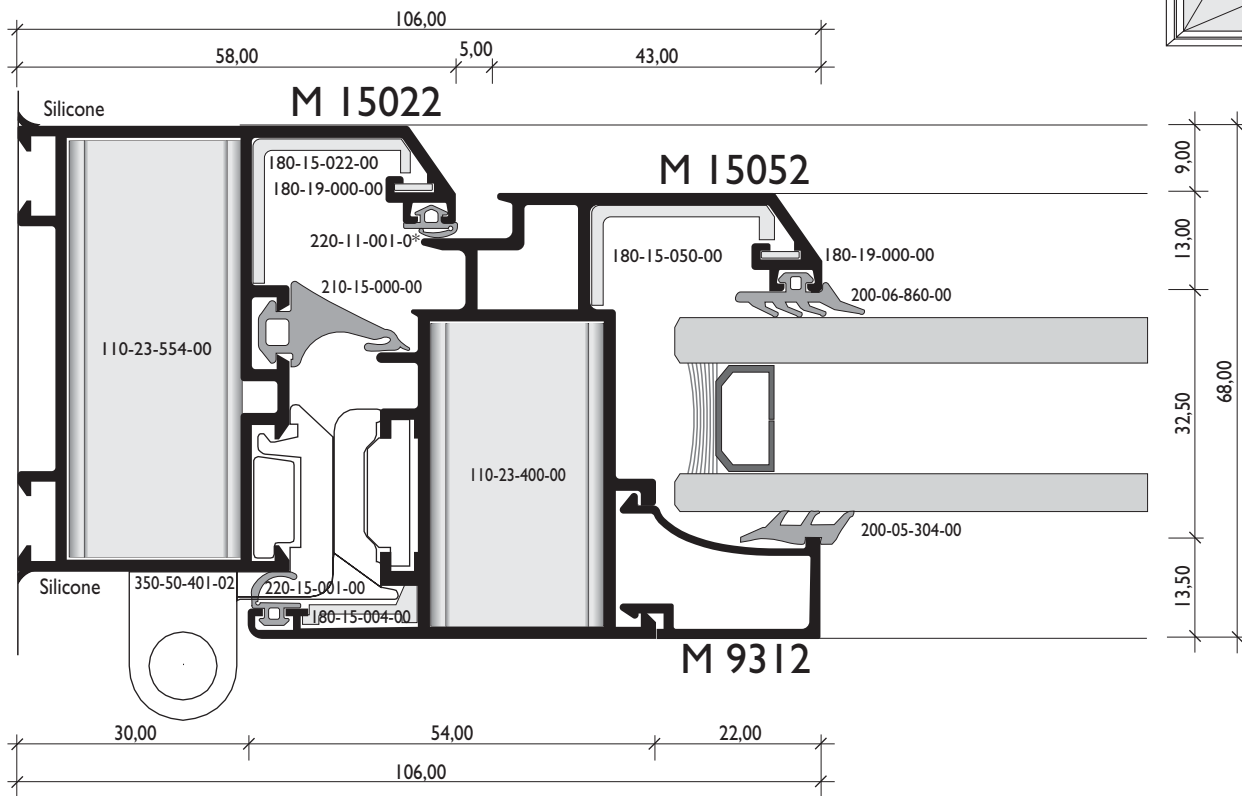
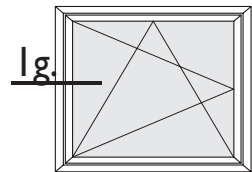
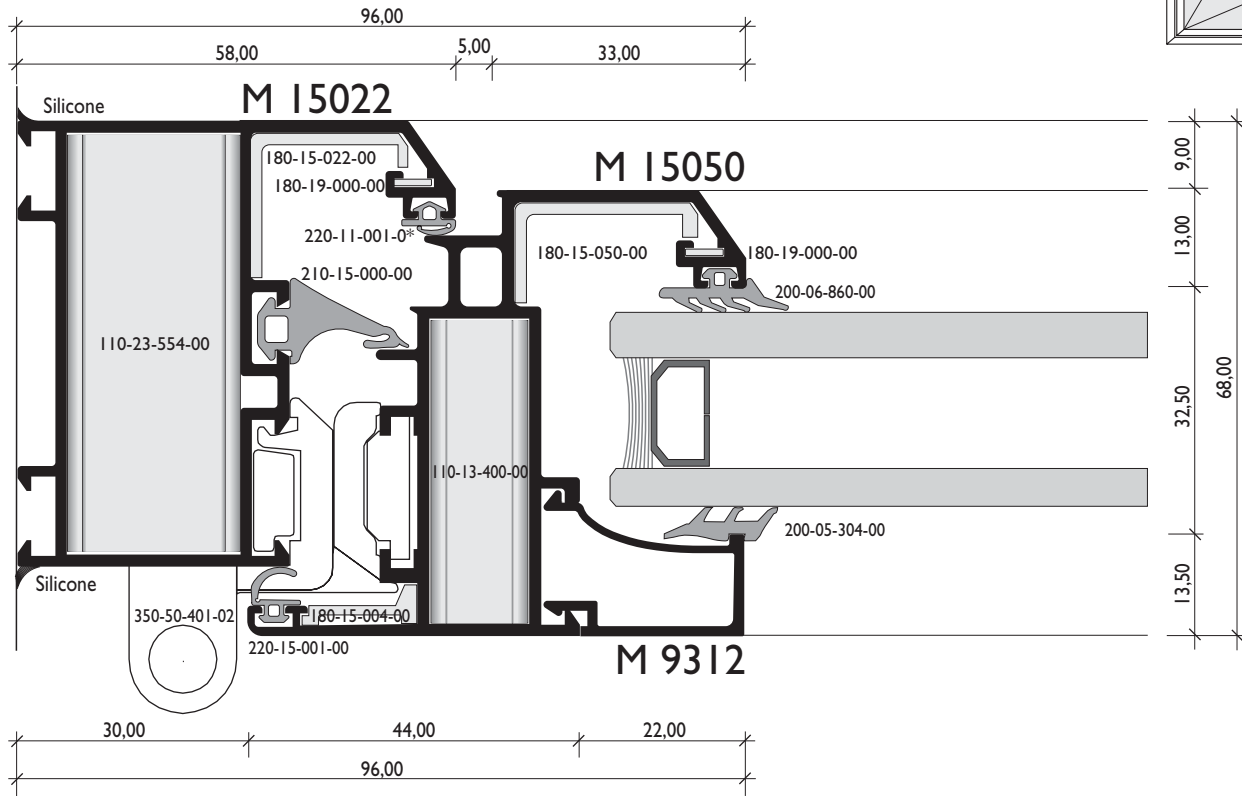
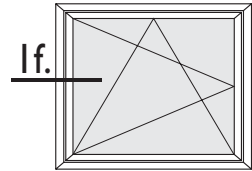

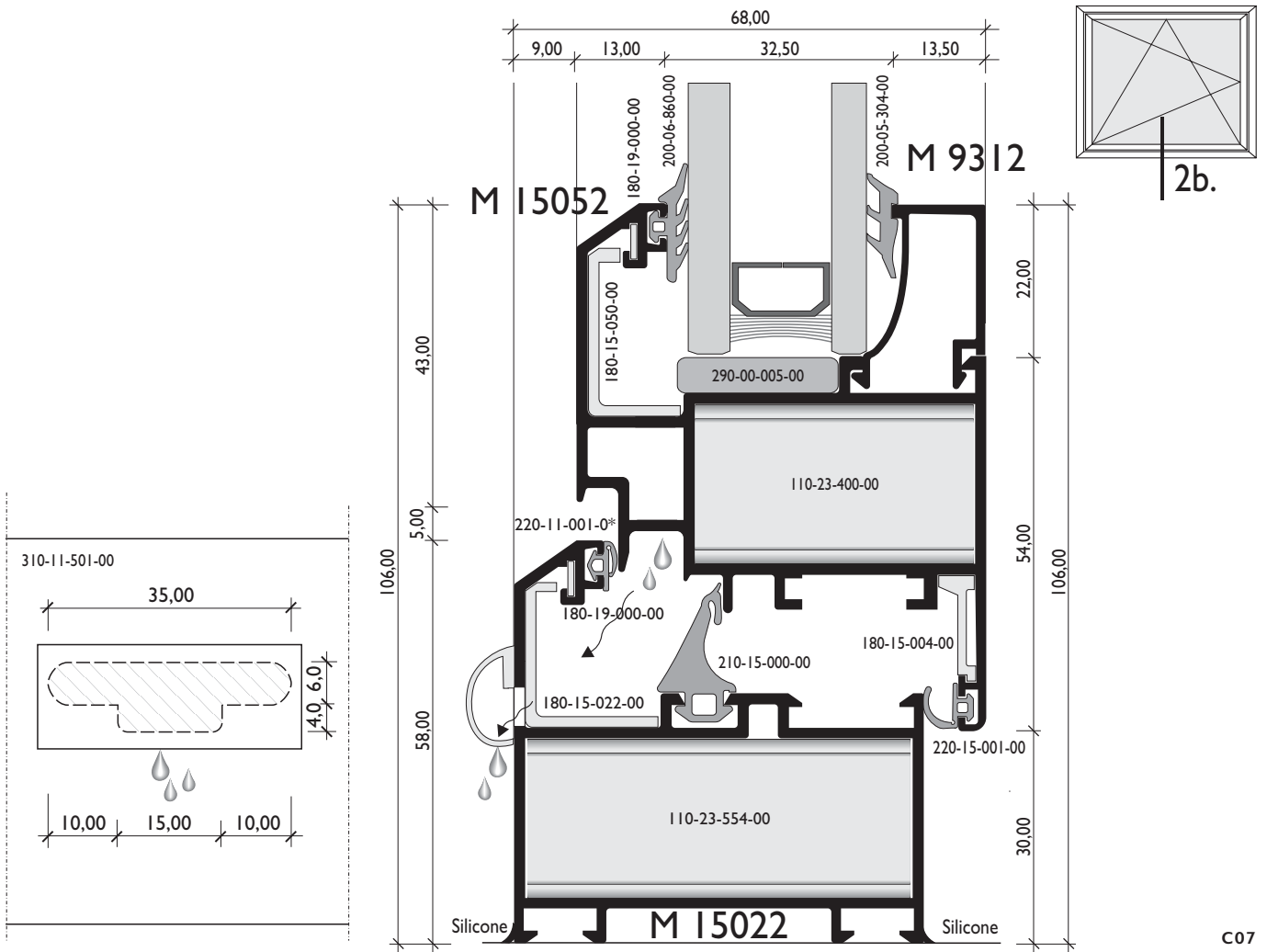
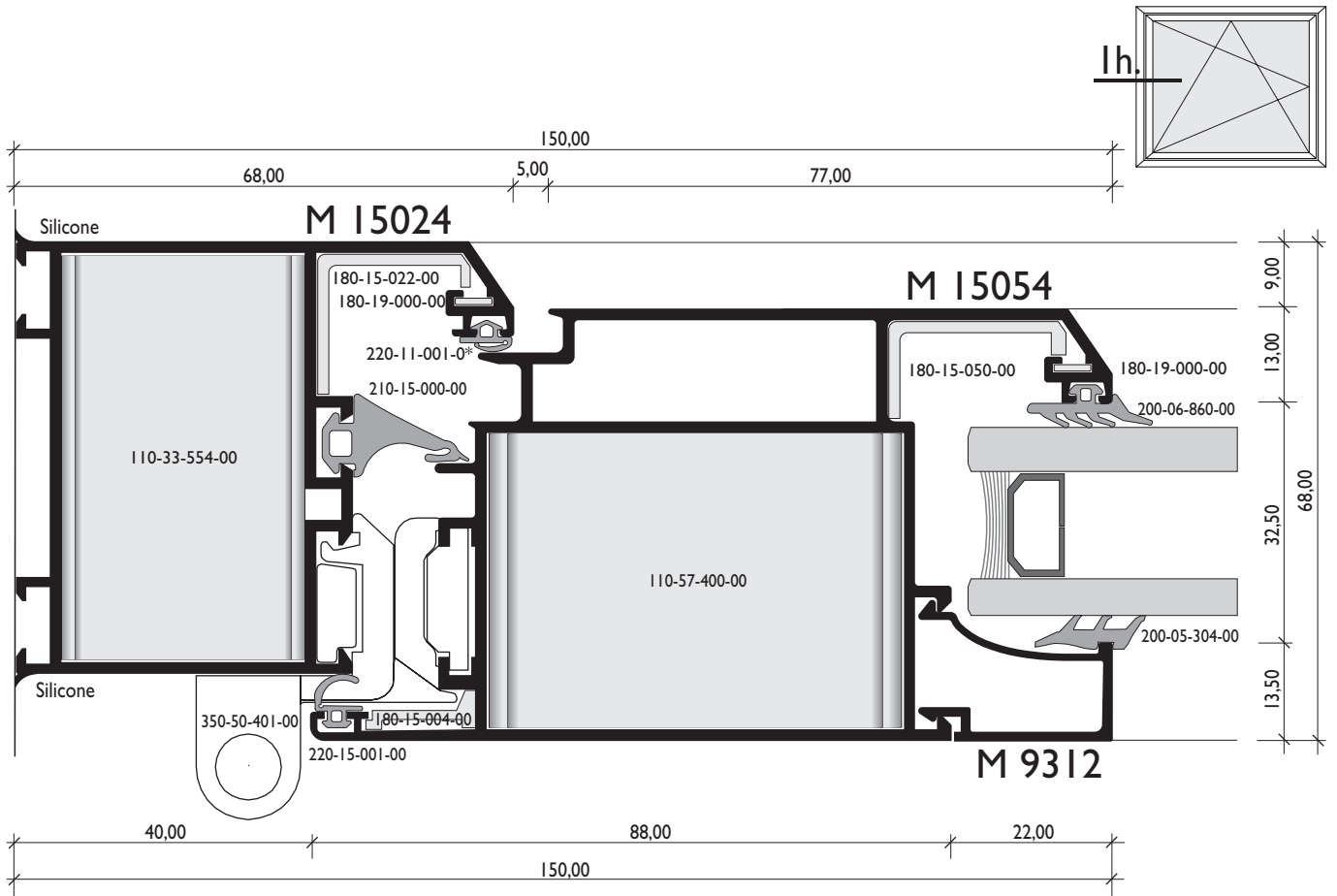

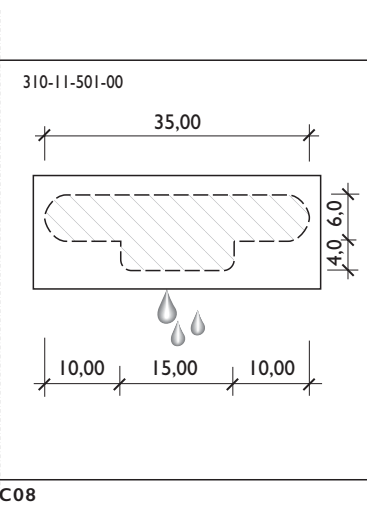
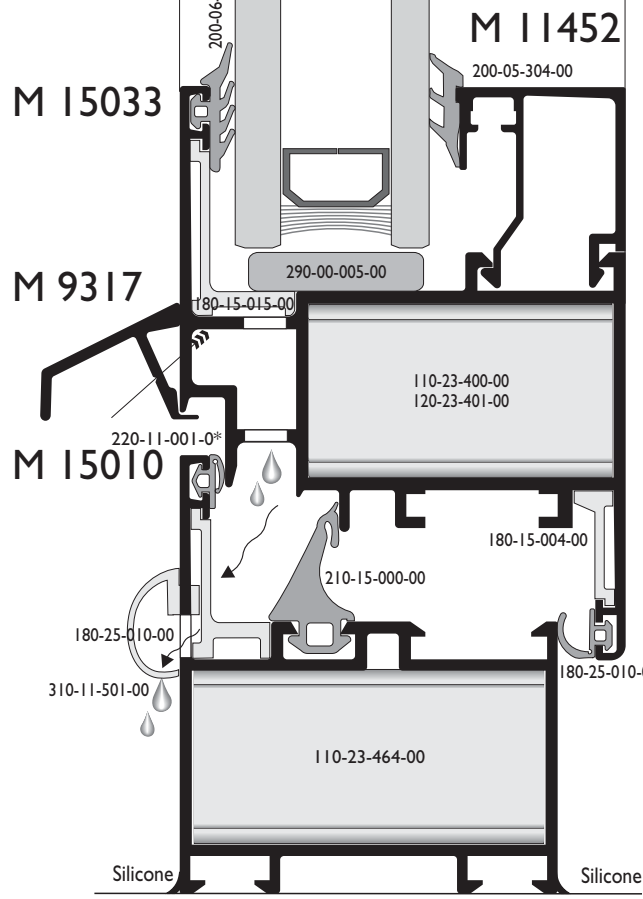
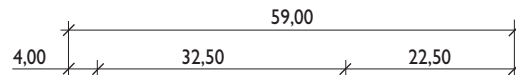
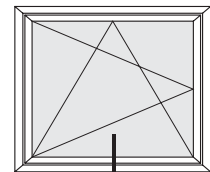
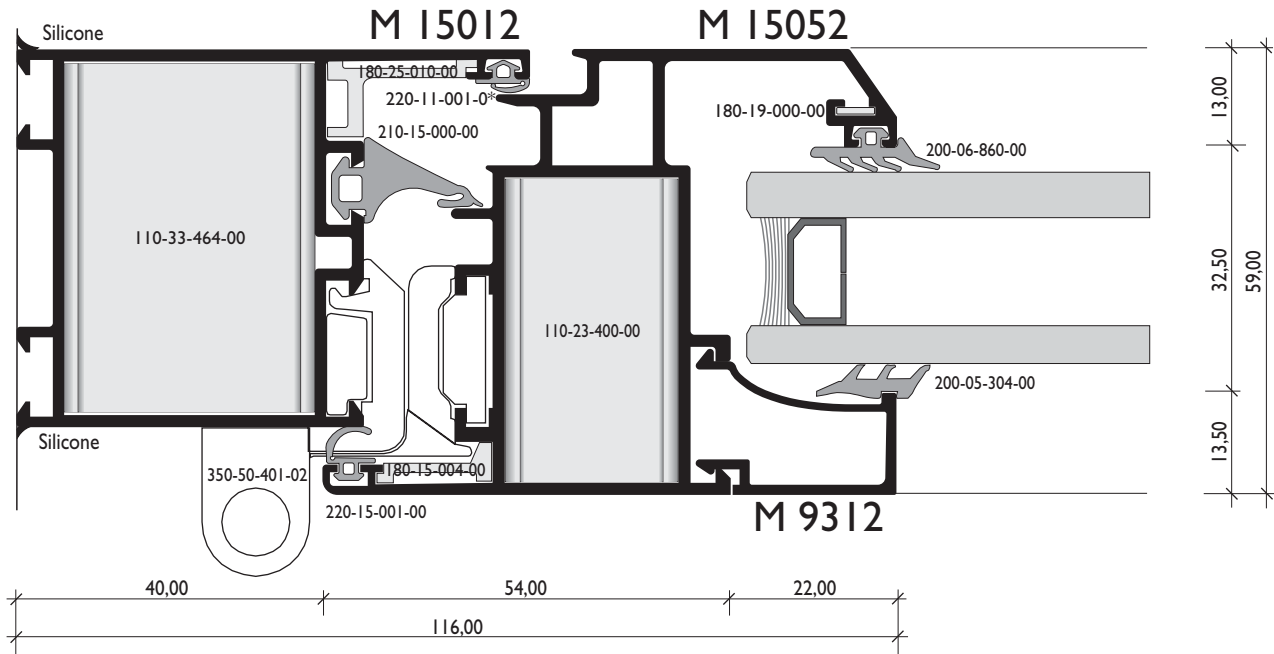
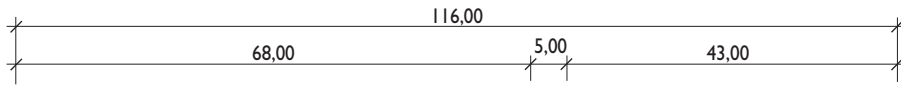
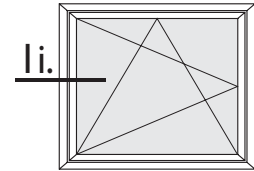

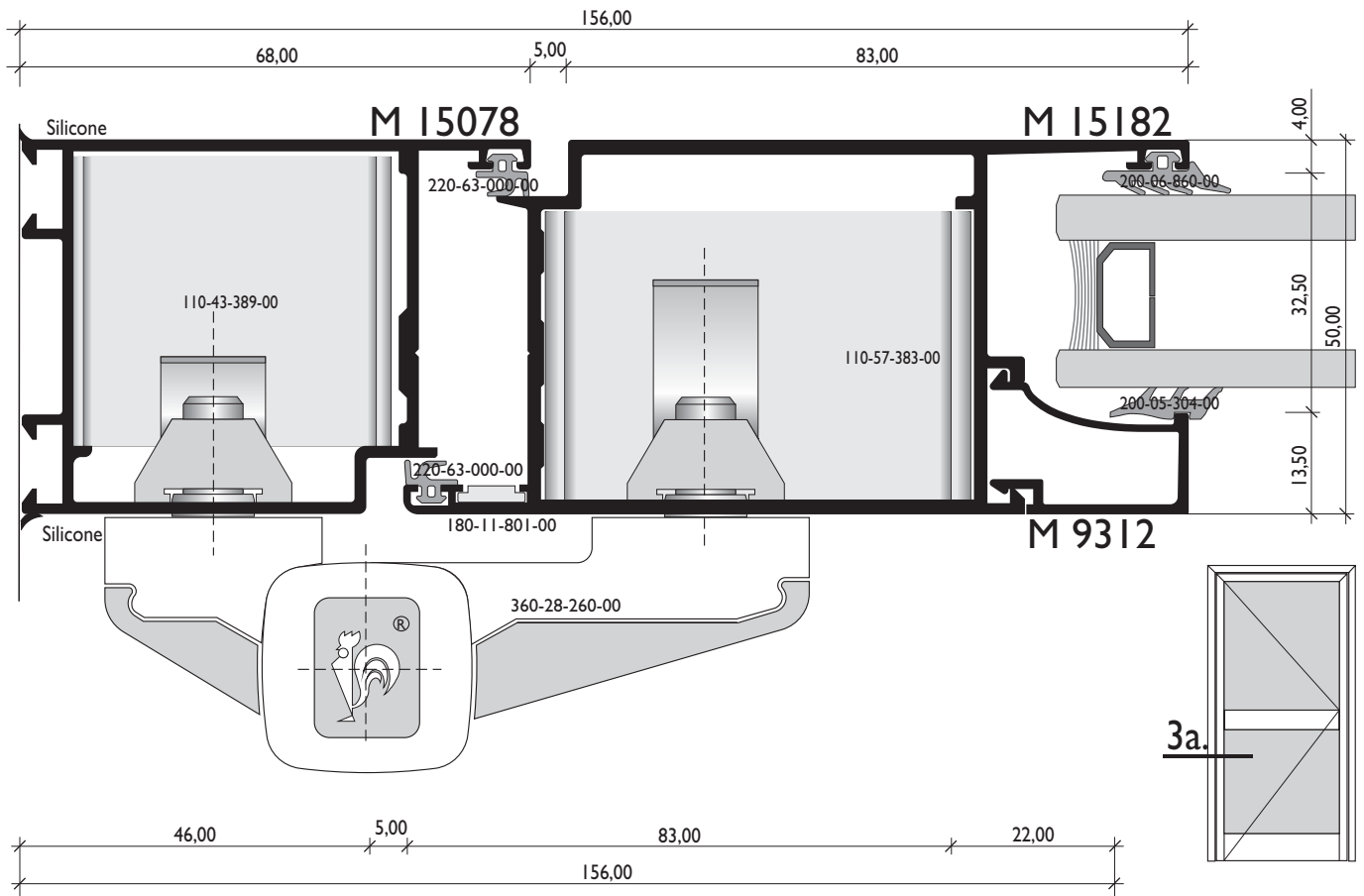
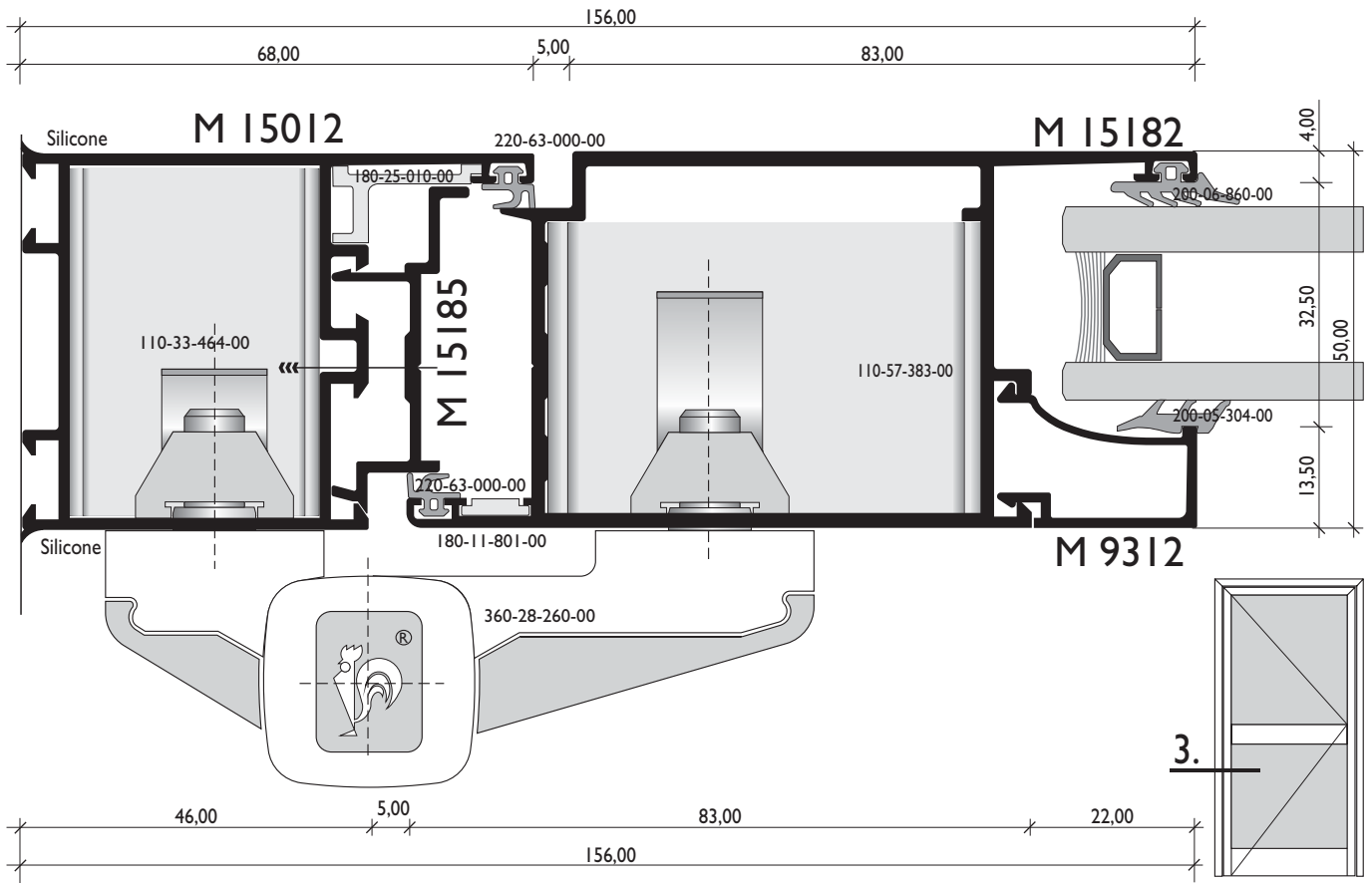

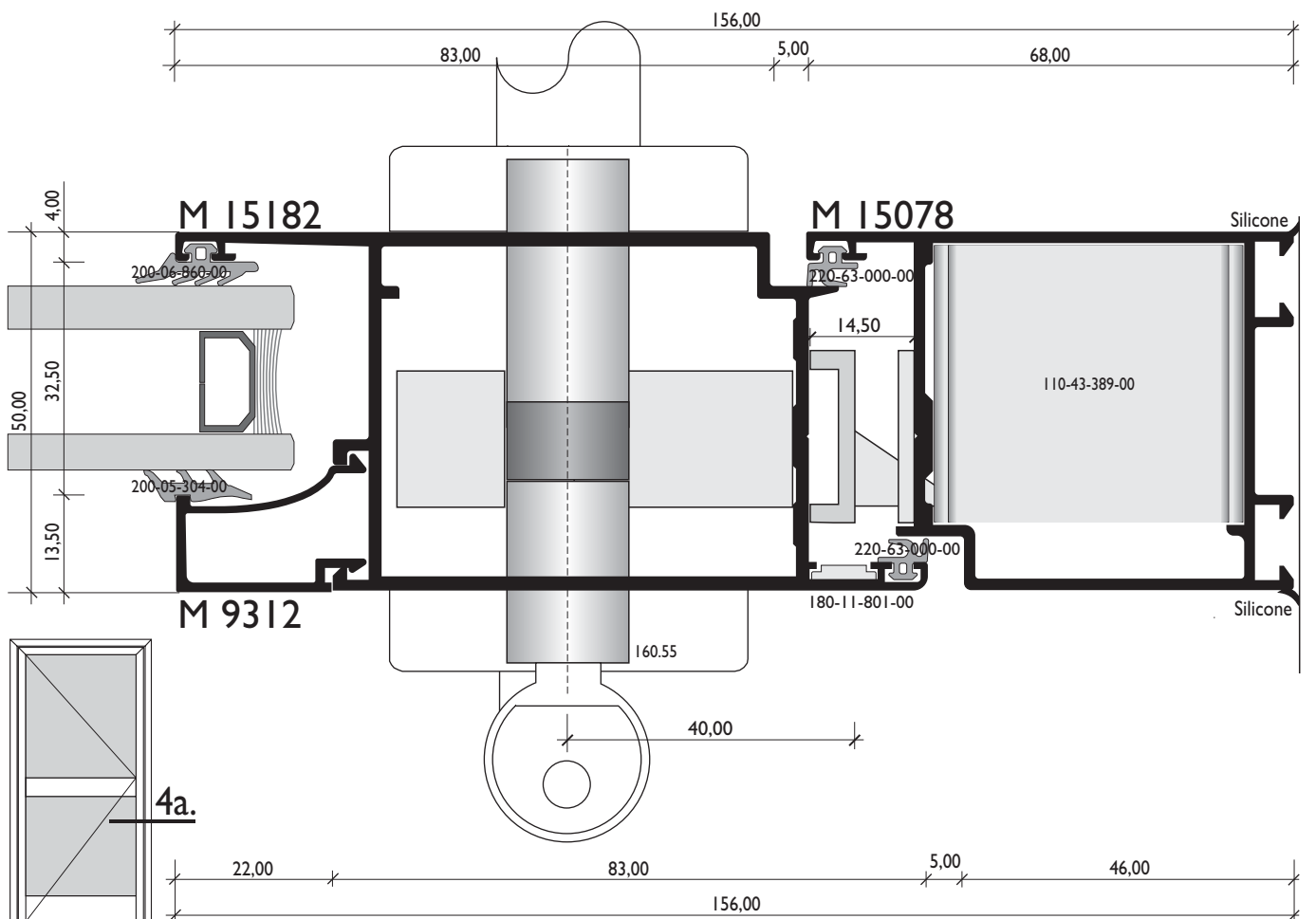
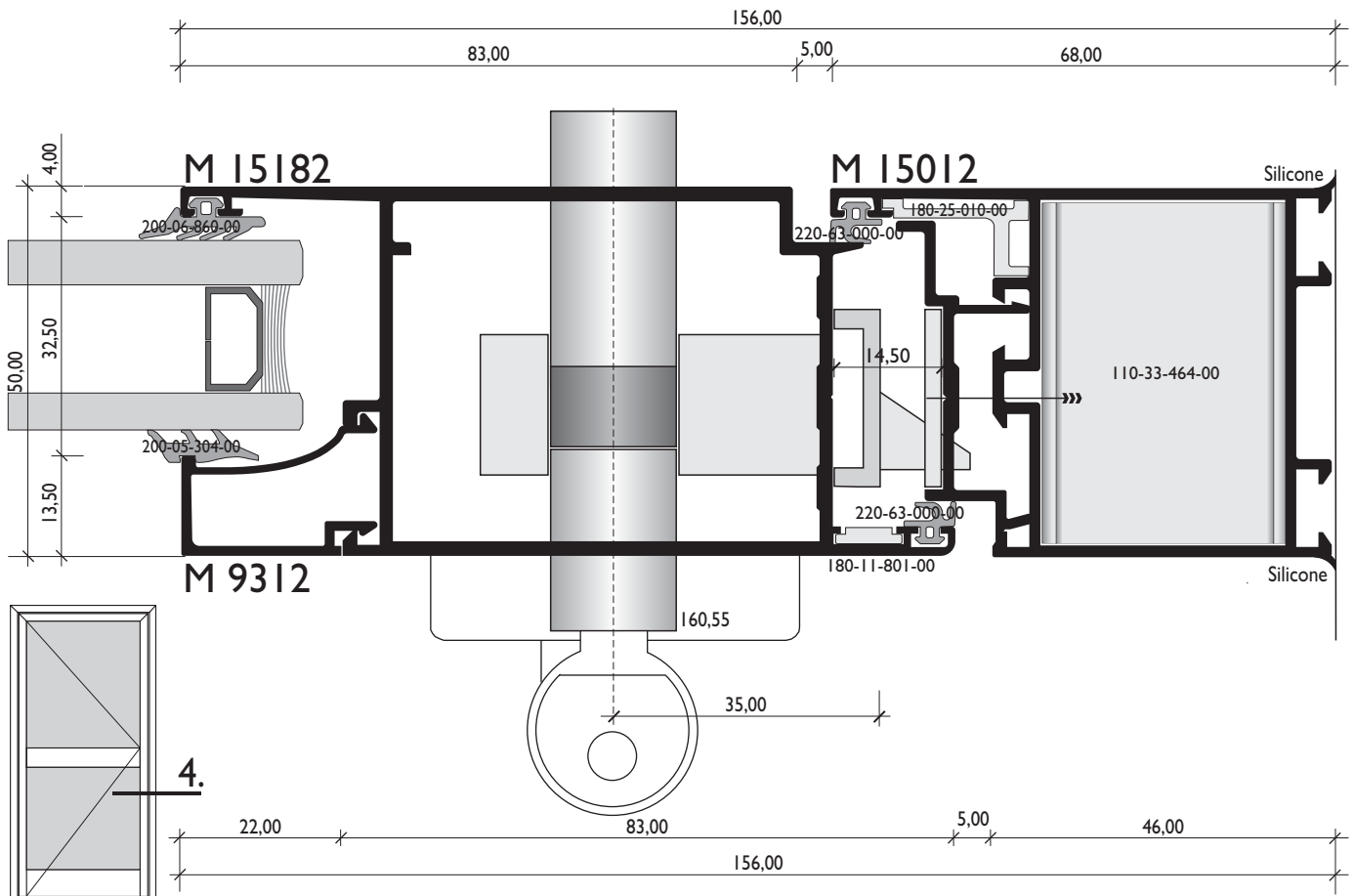

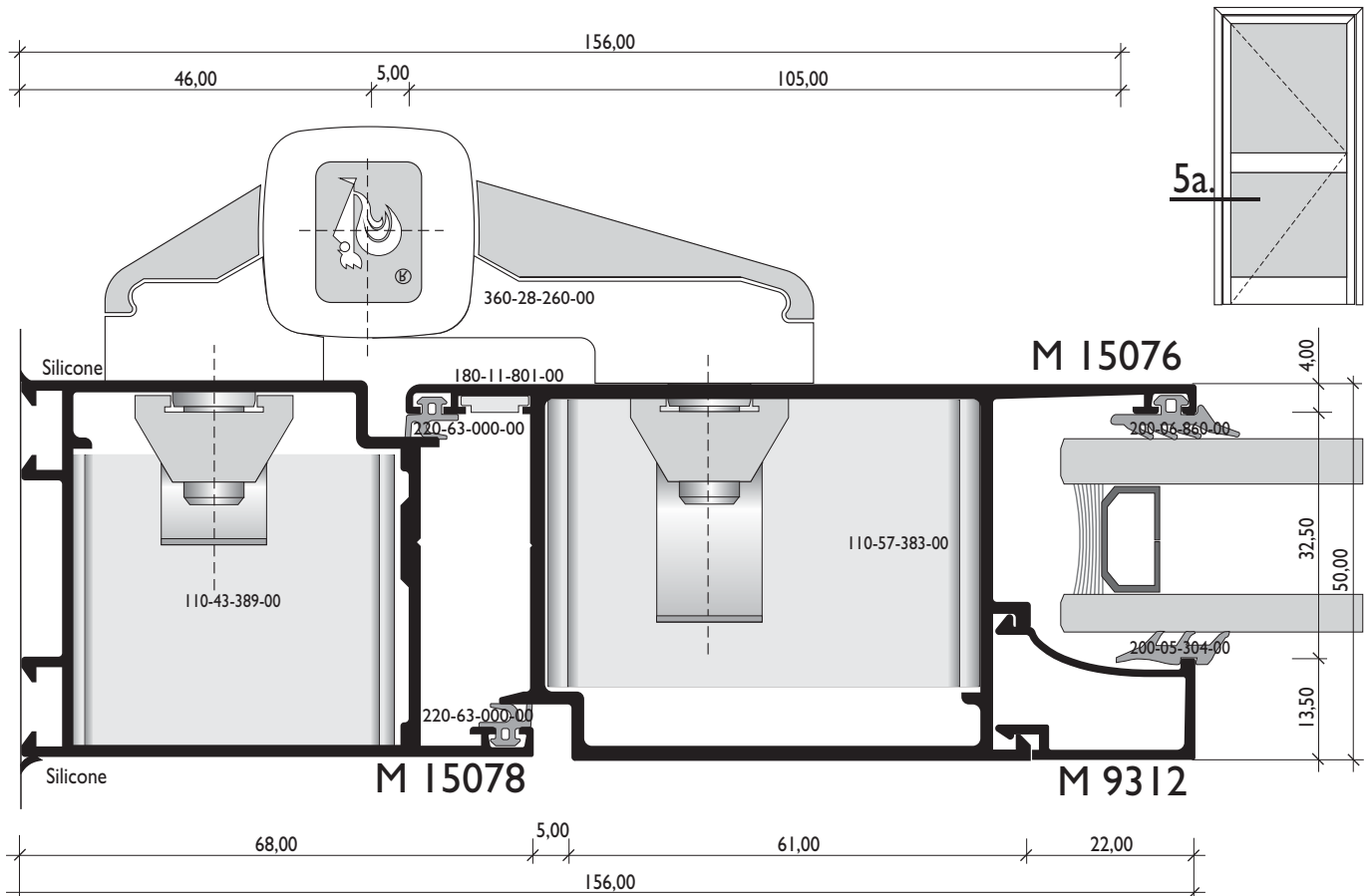
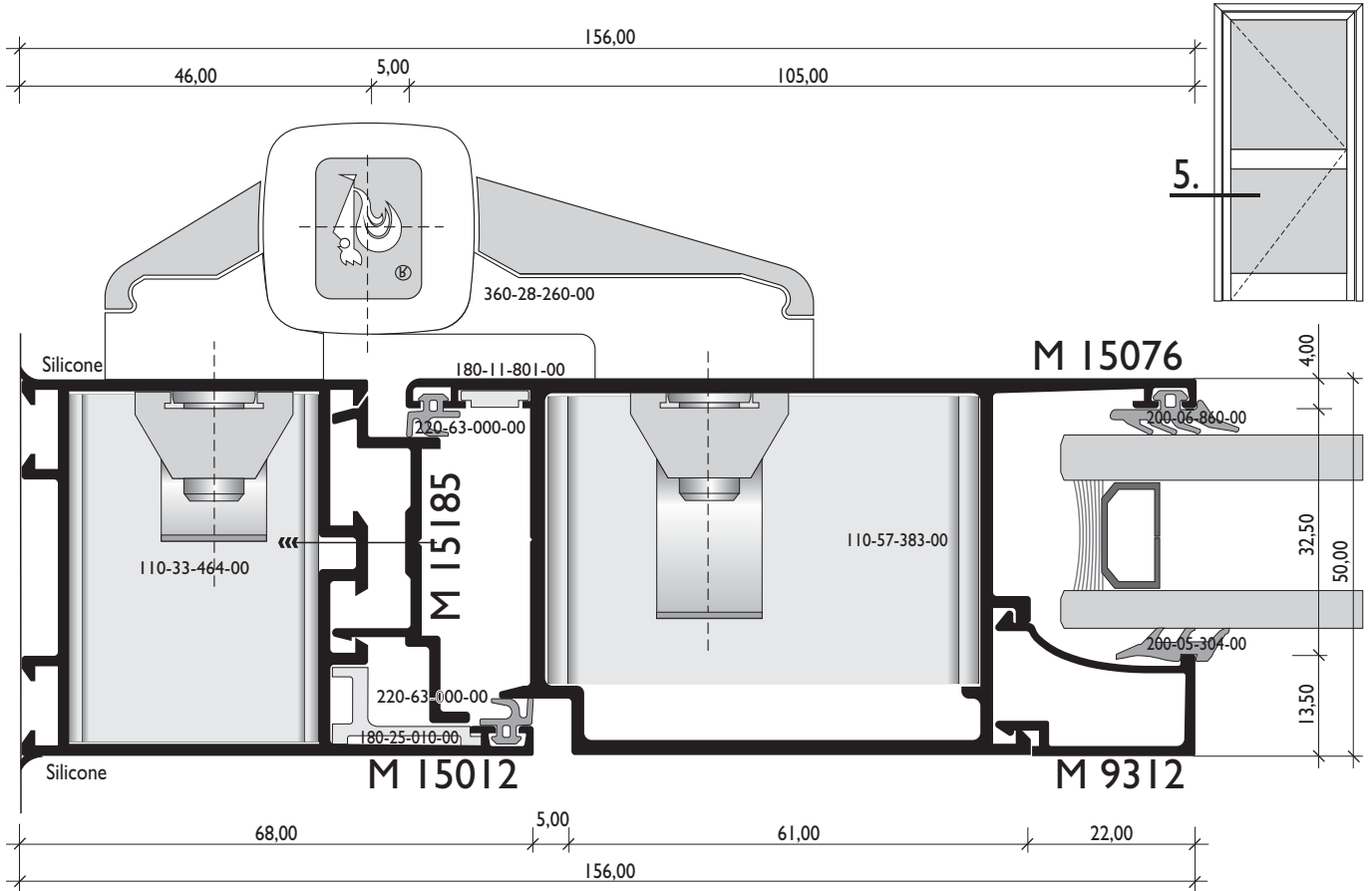

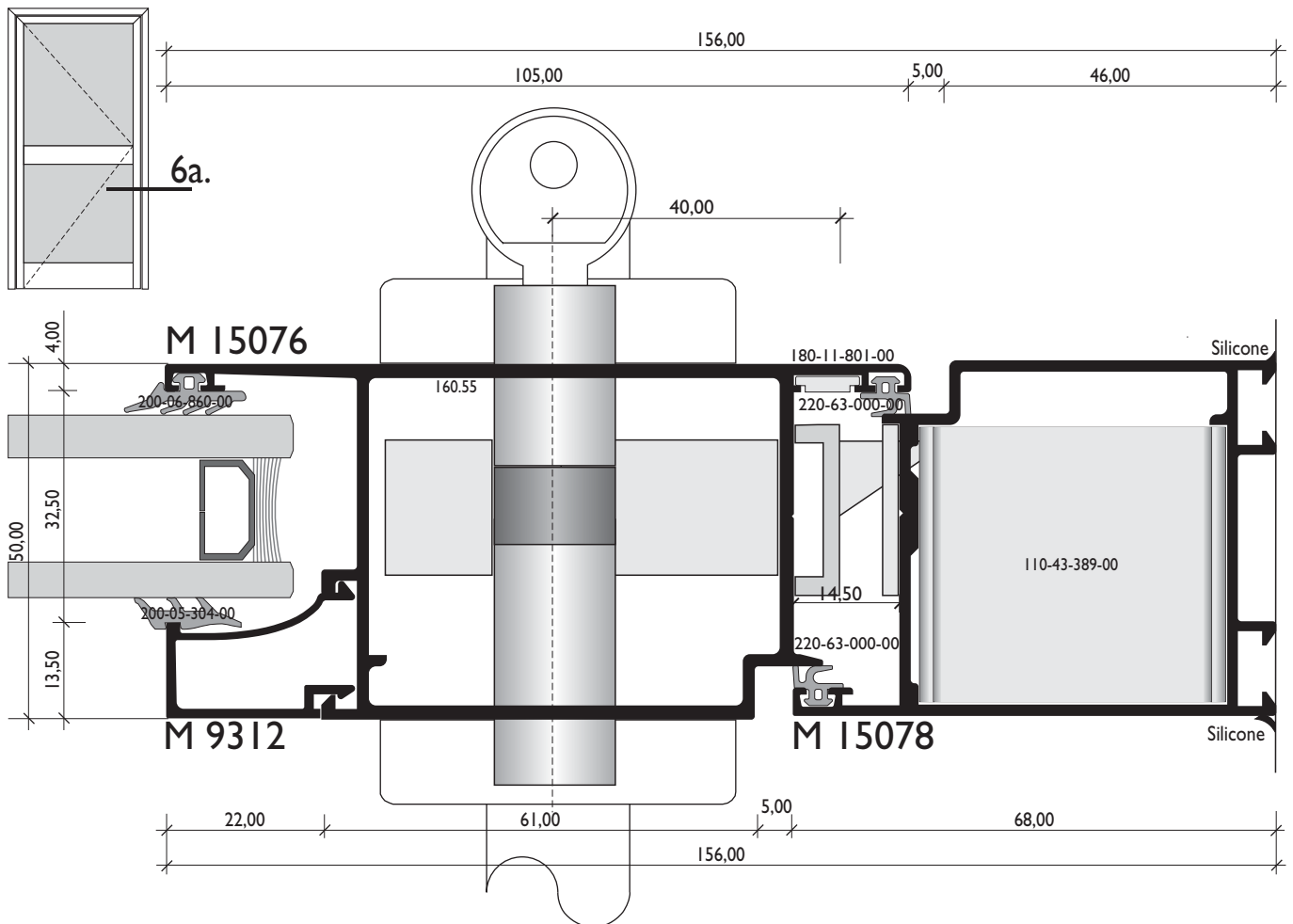
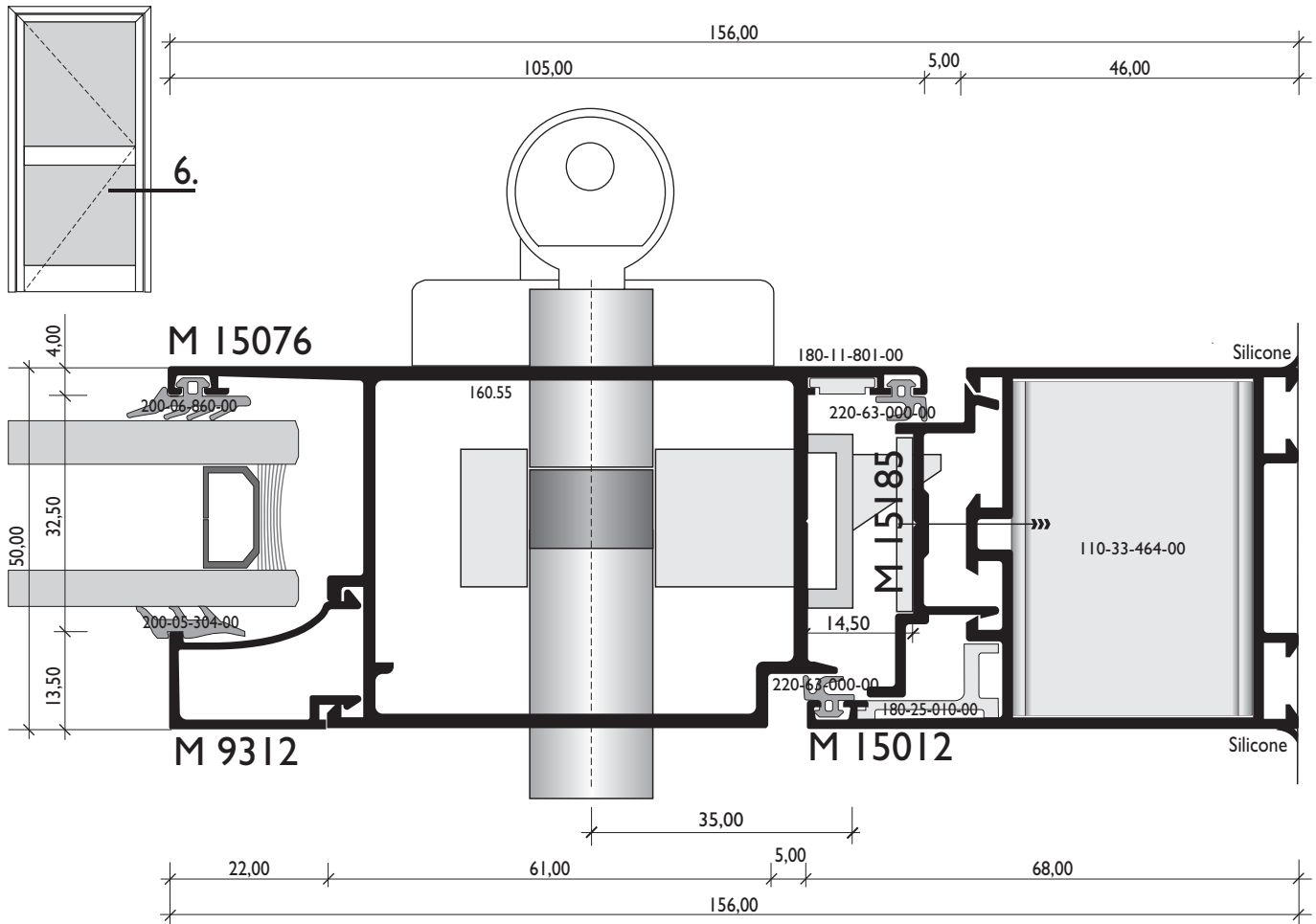

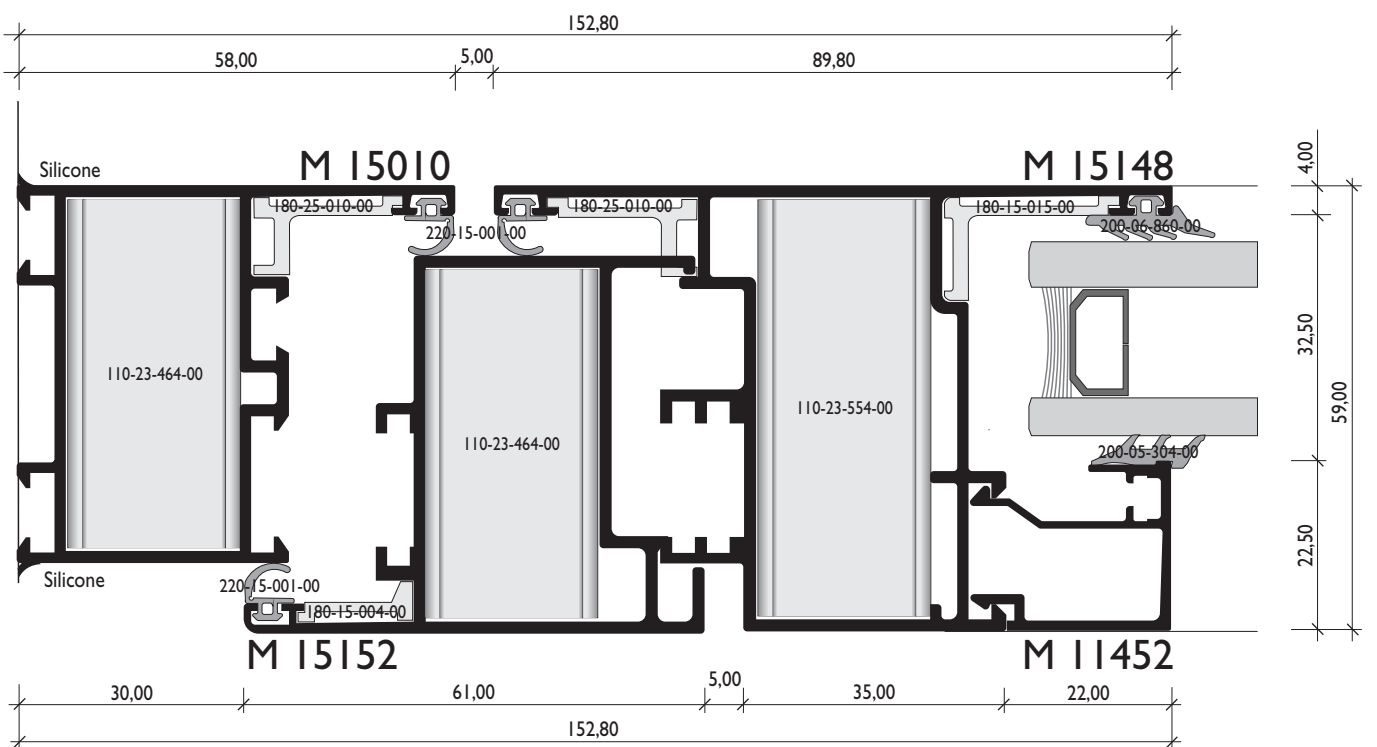
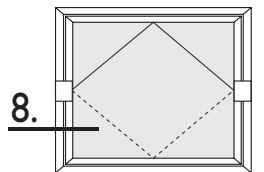
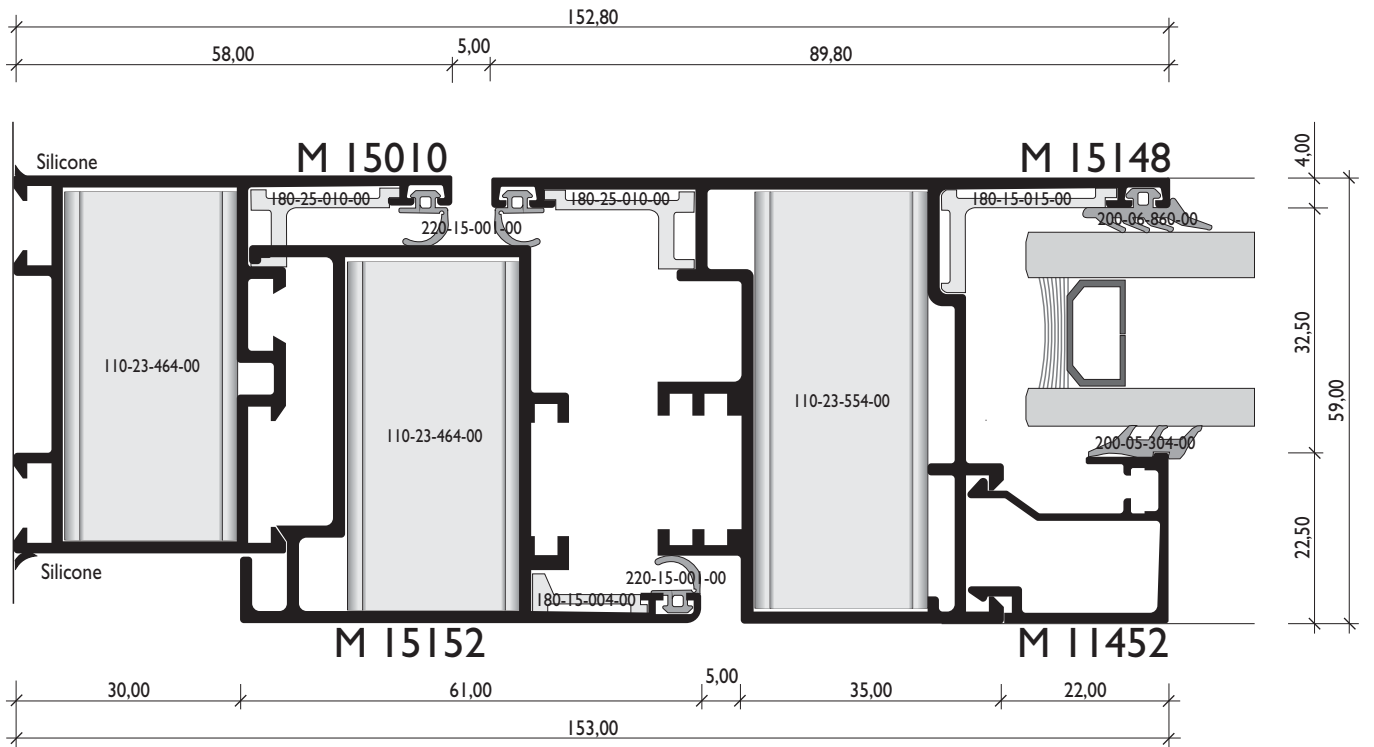
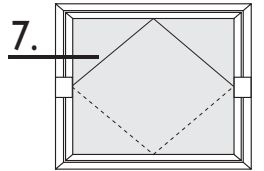

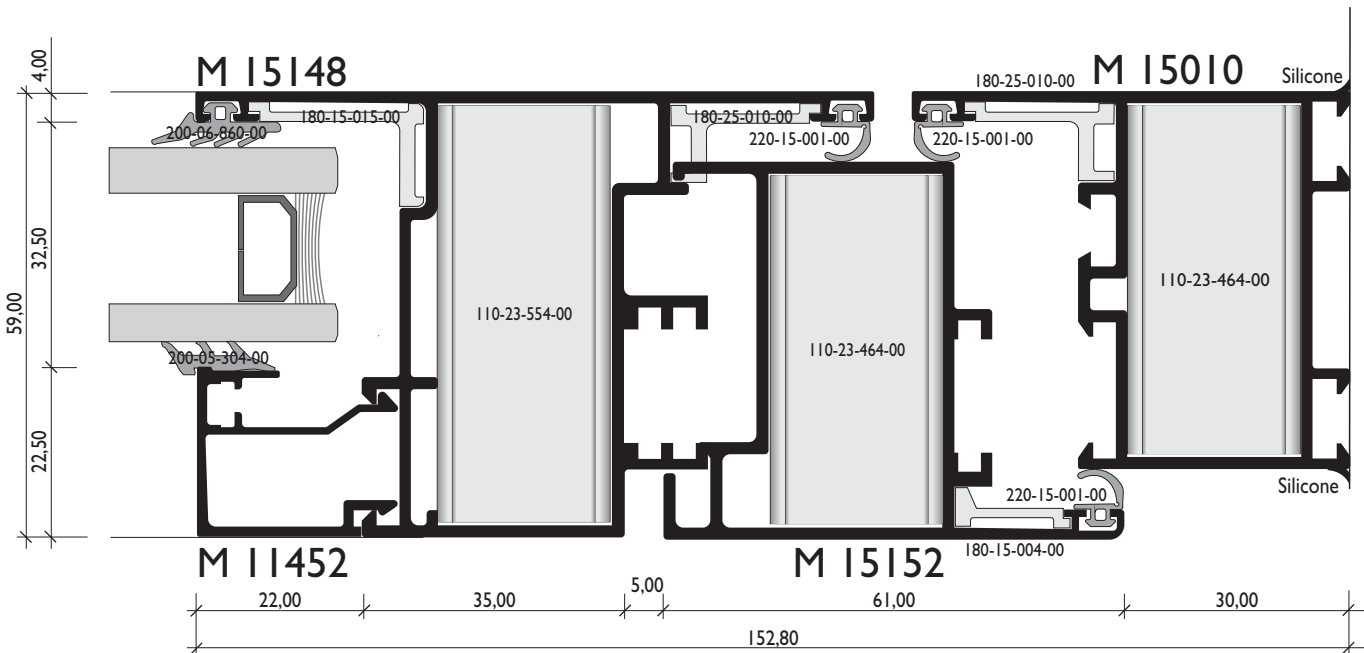
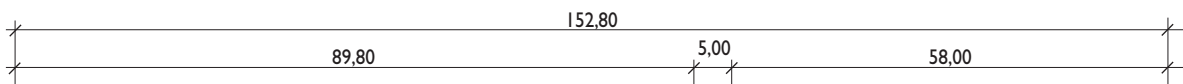
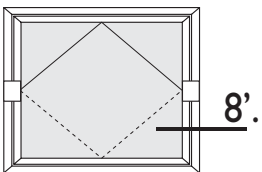
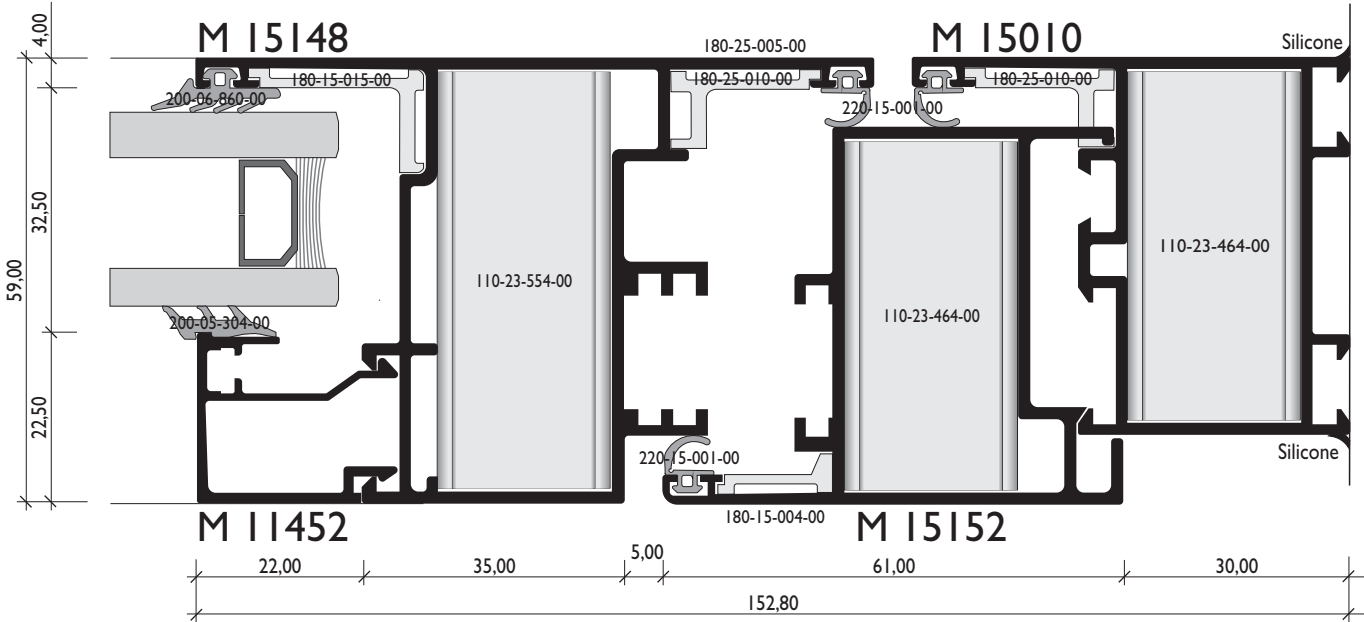
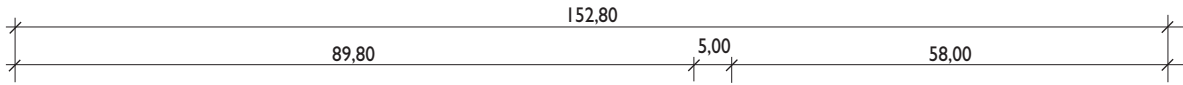
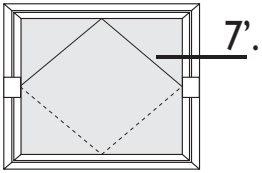

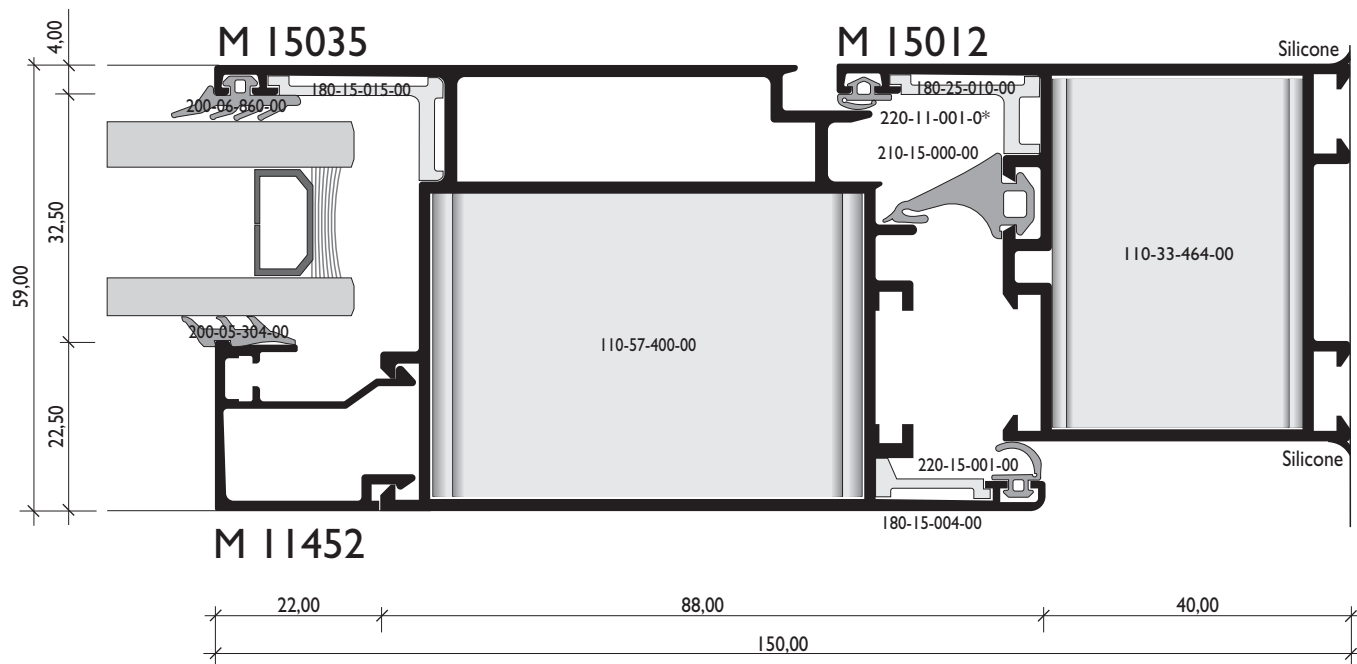
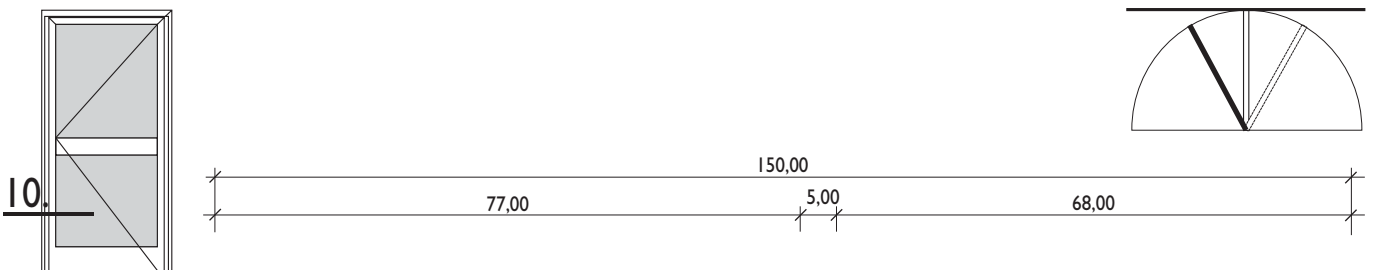
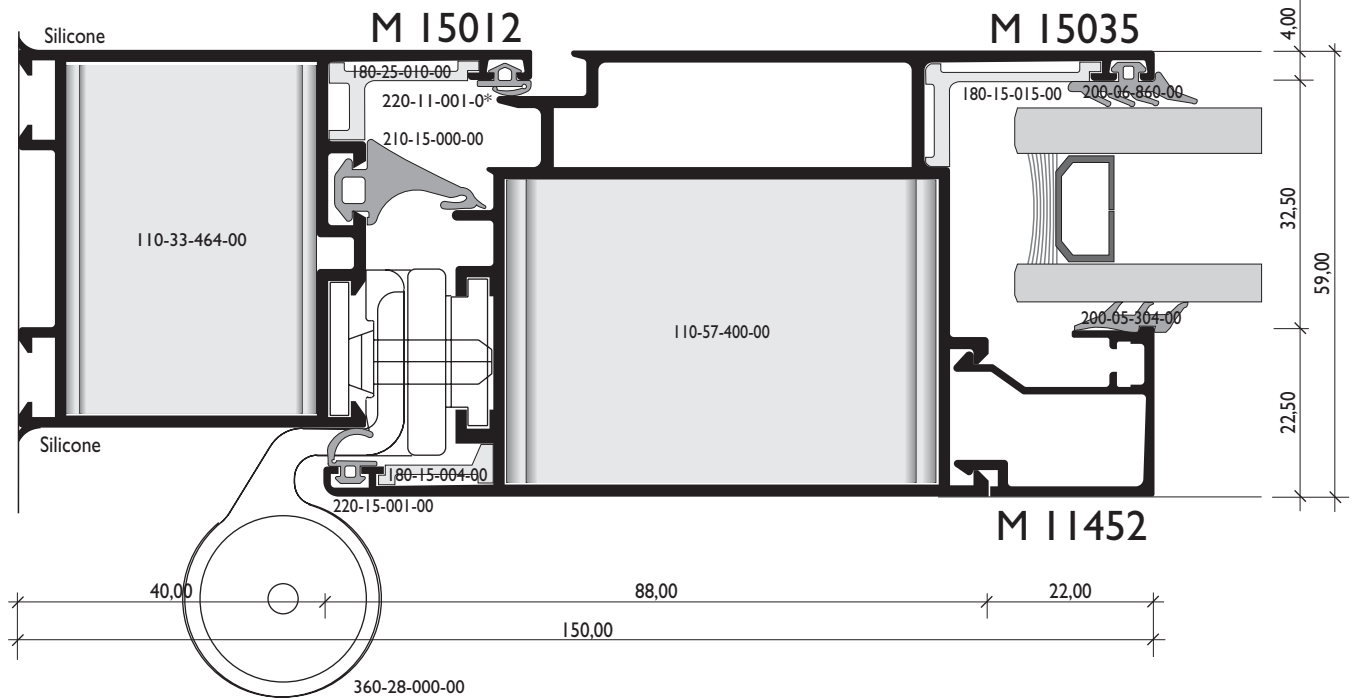
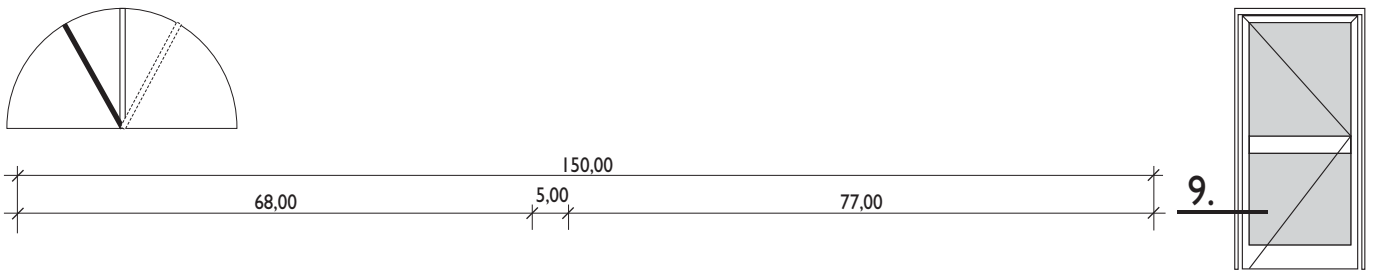

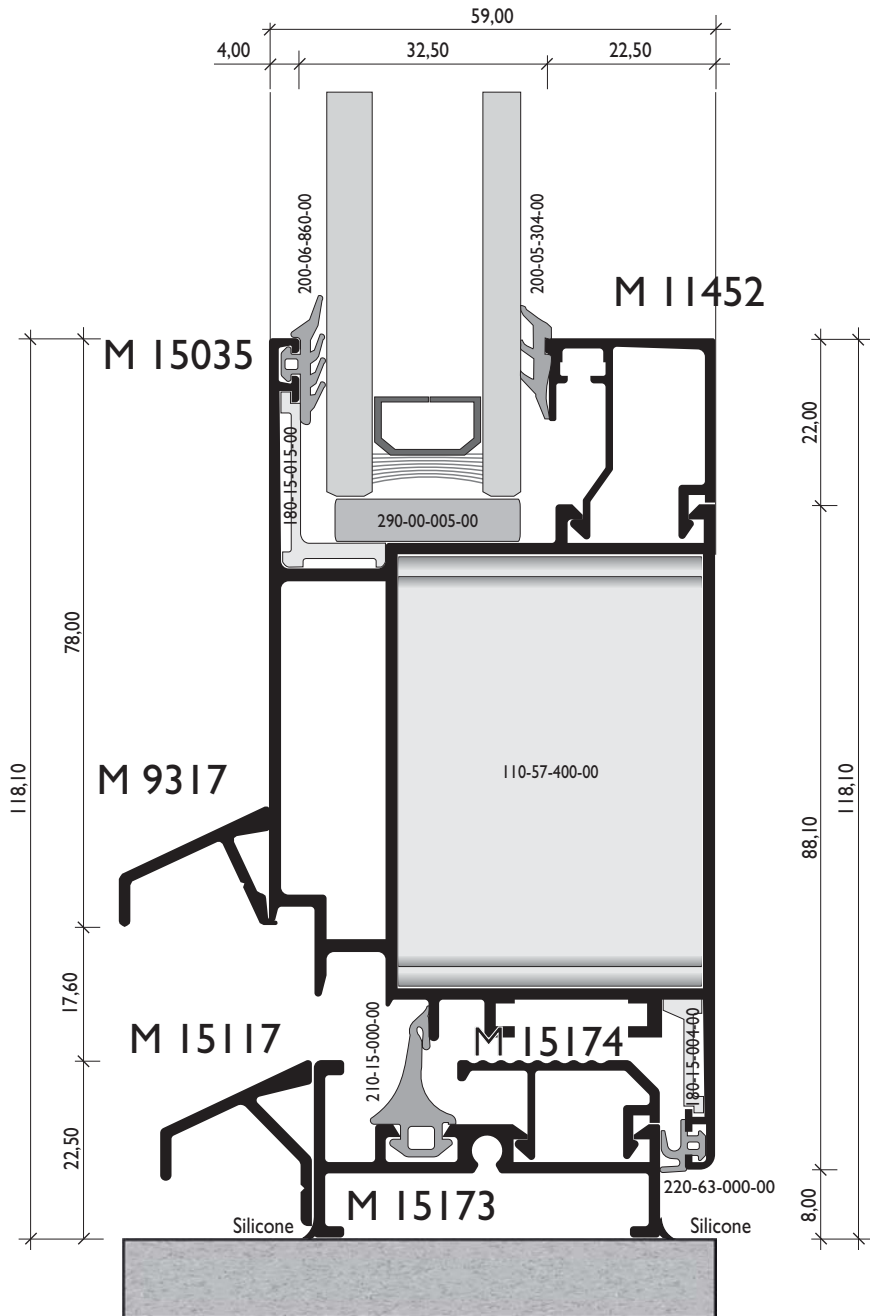
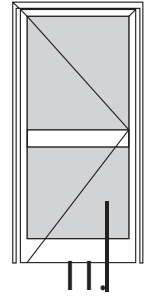
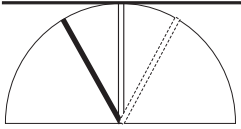

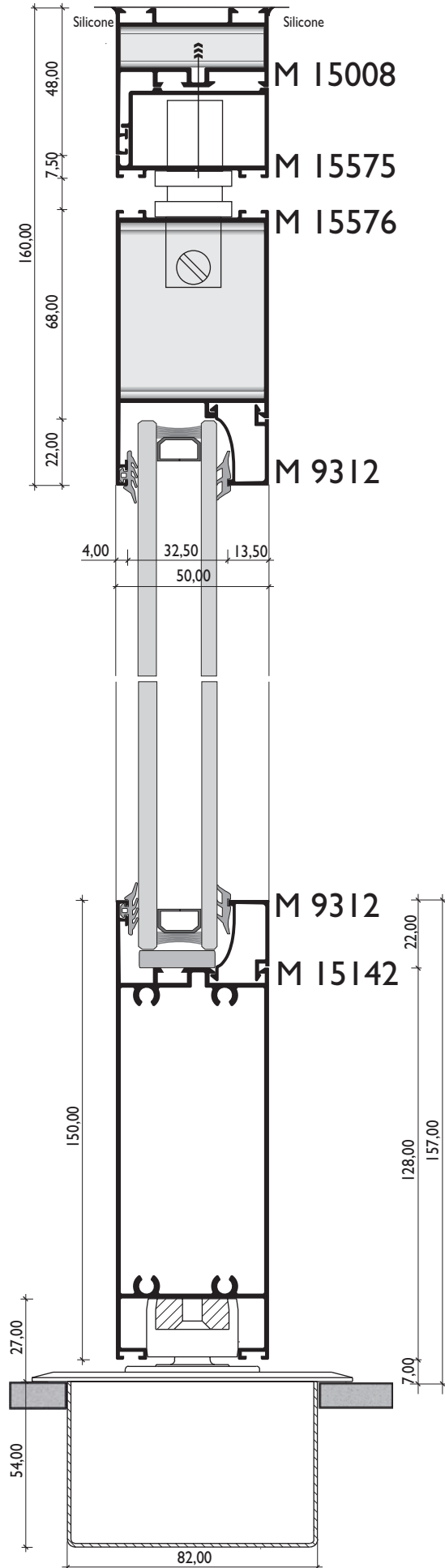

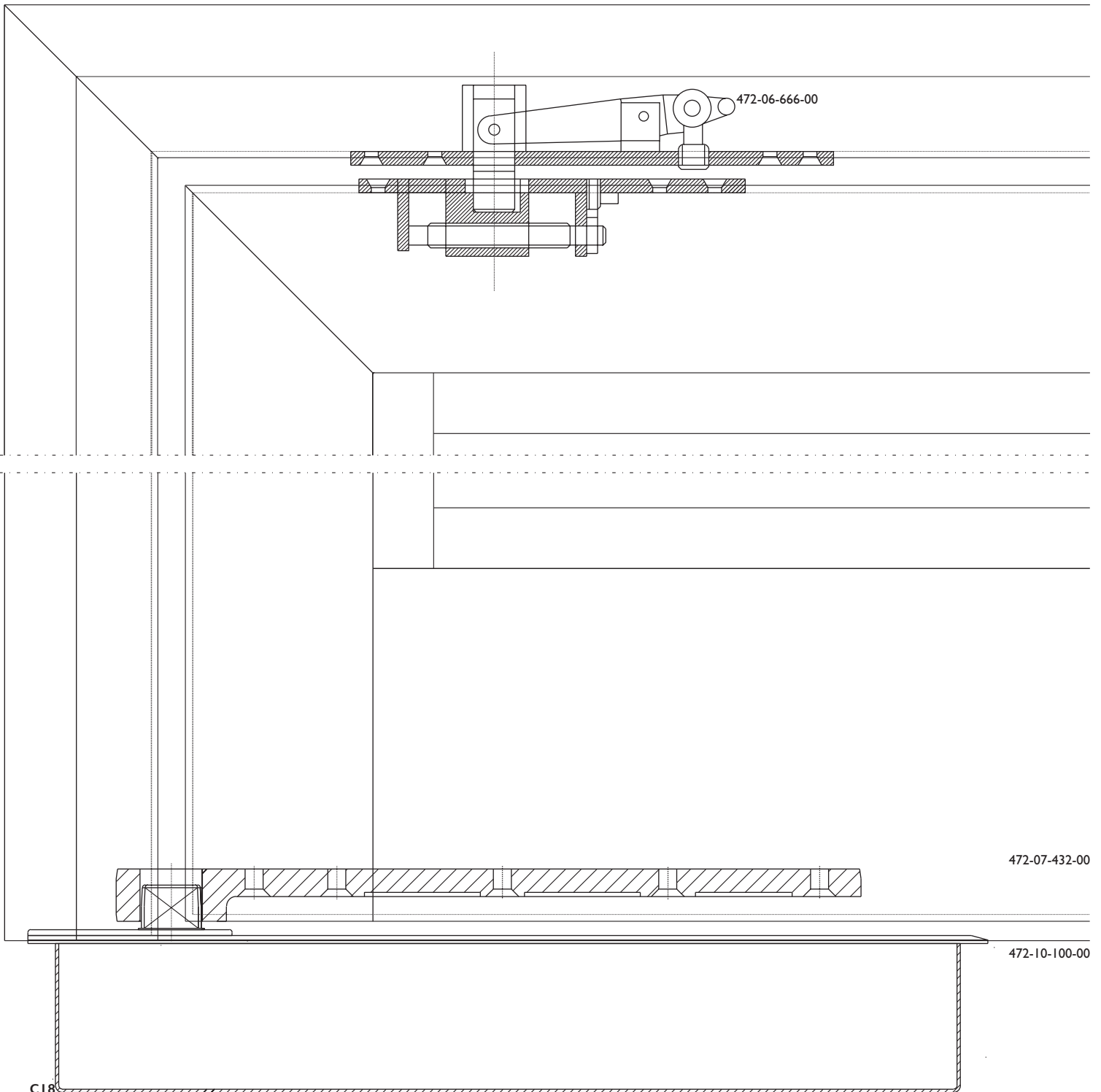
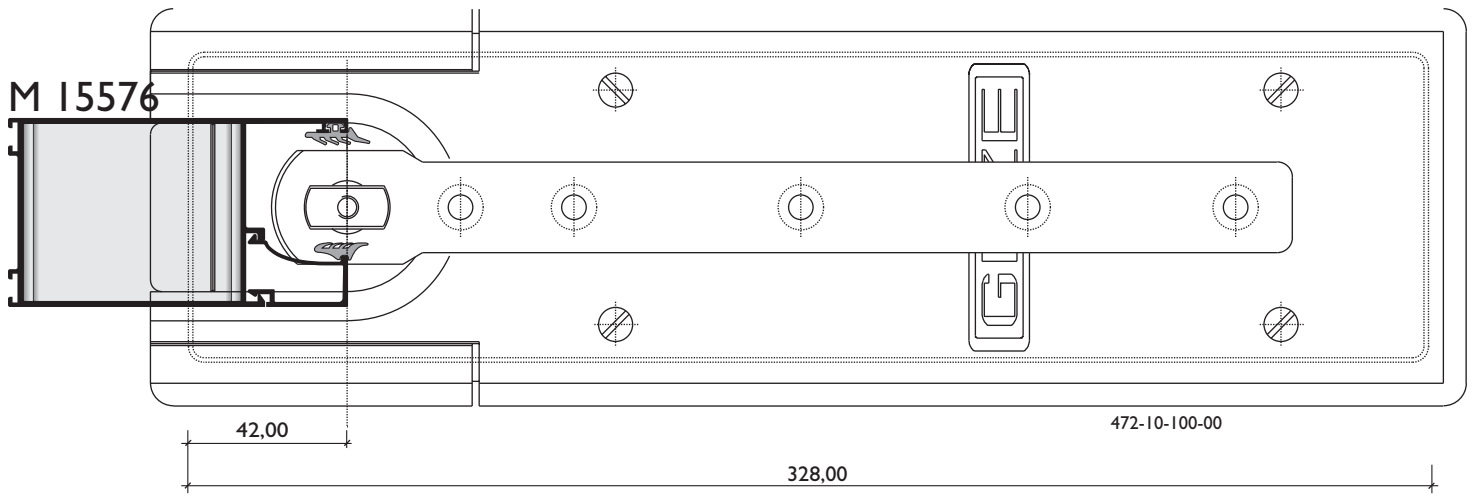

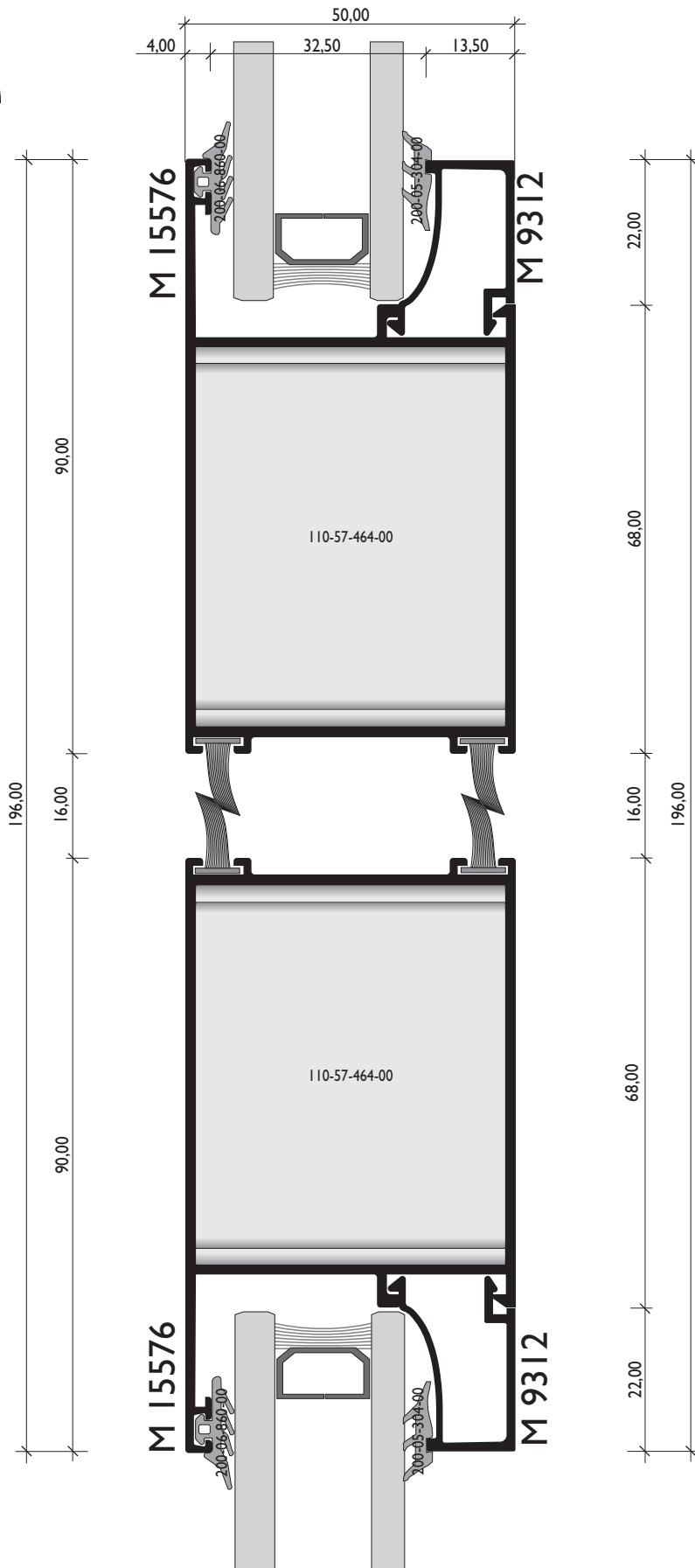
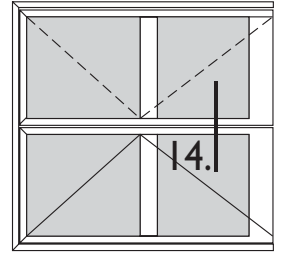
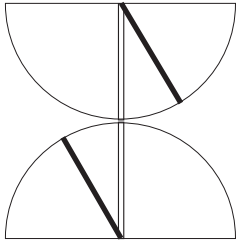

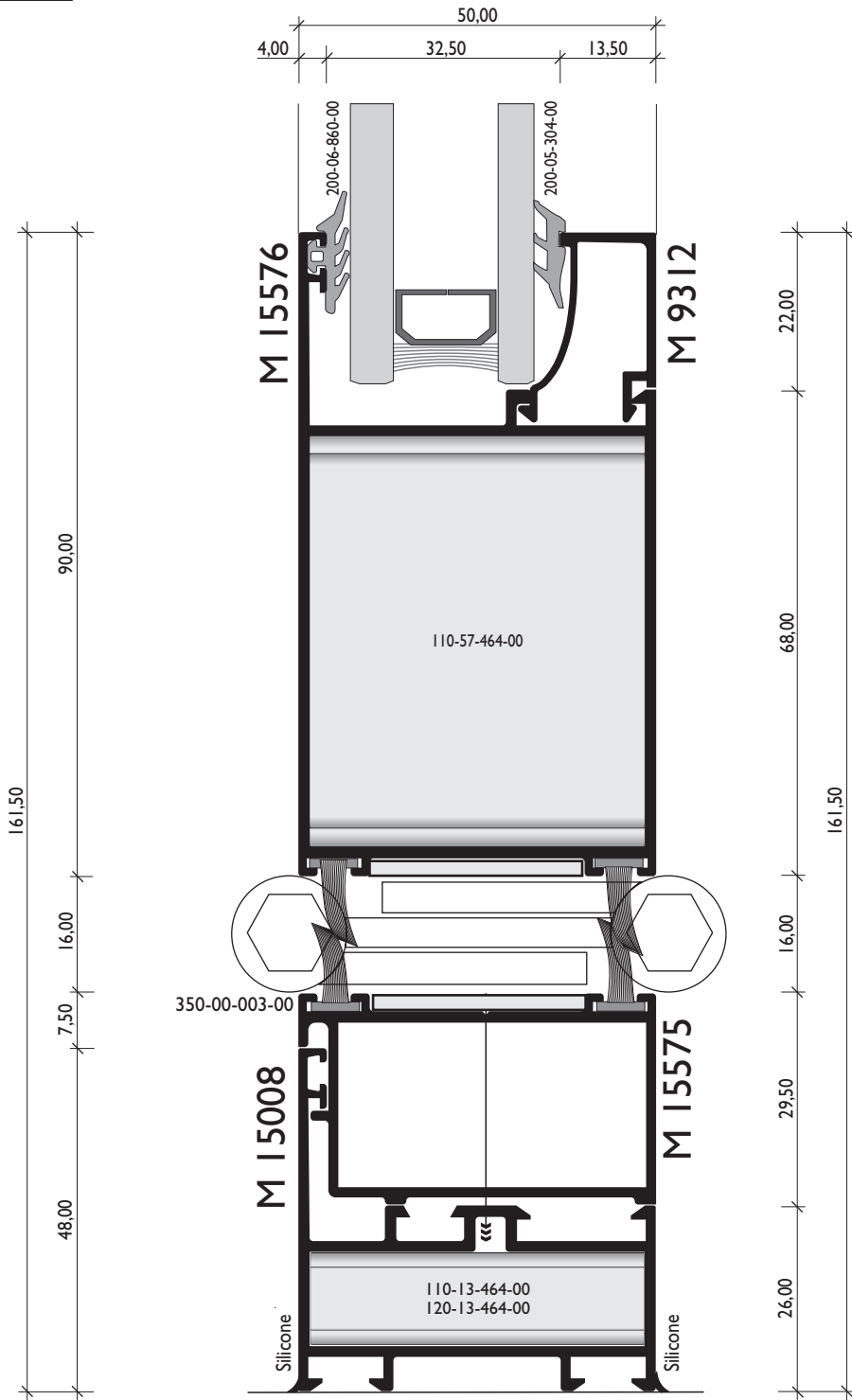
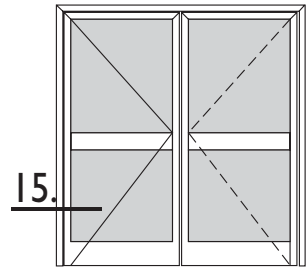
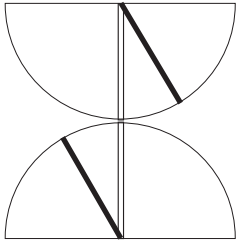

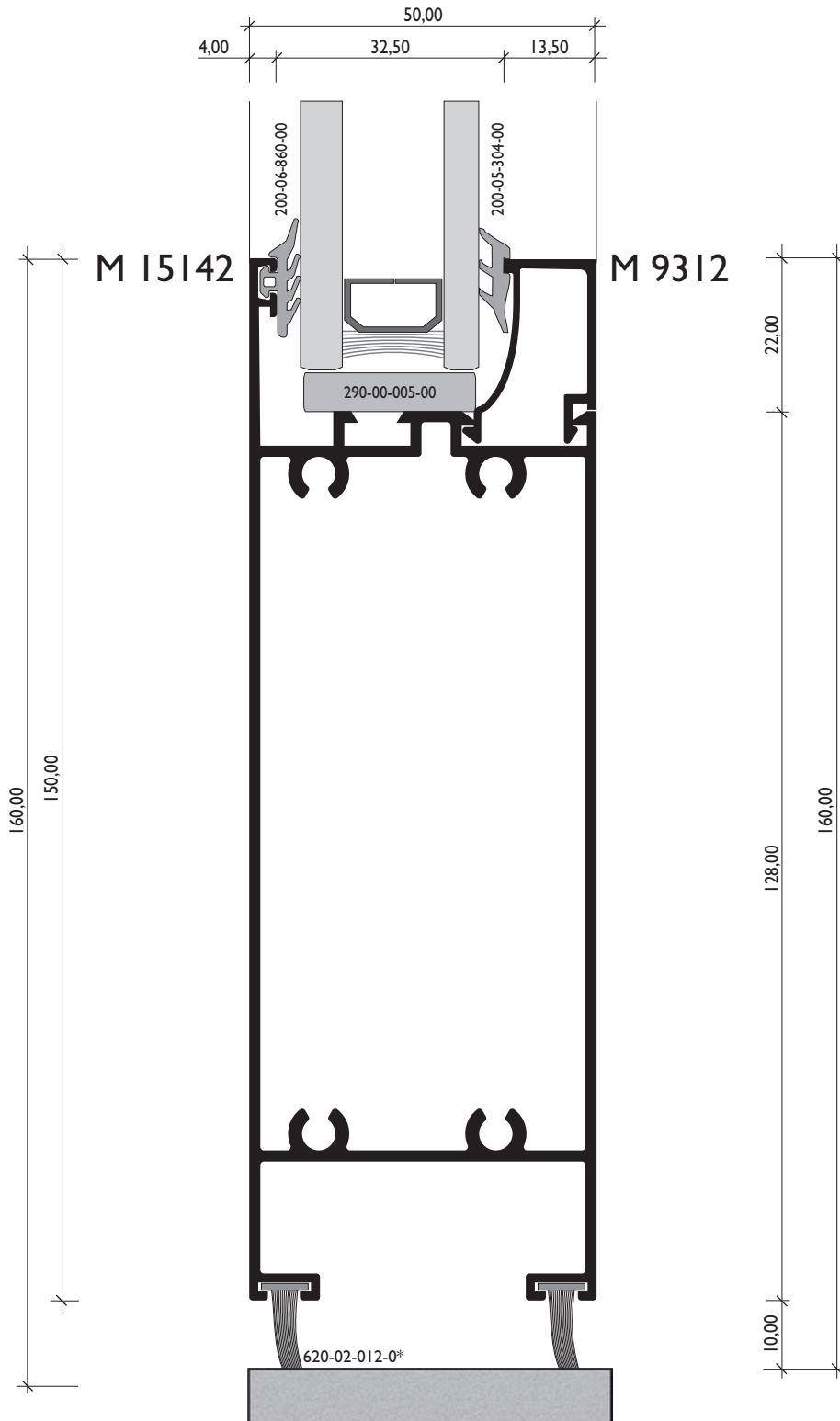
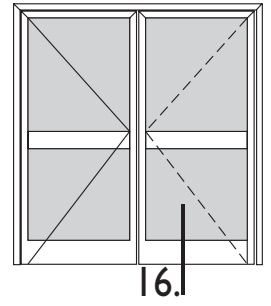
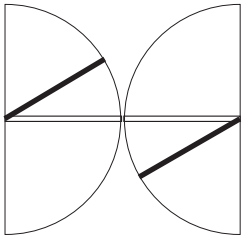

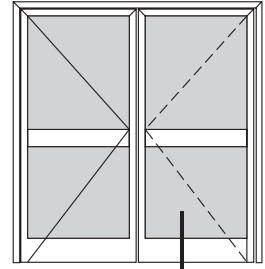

17.]

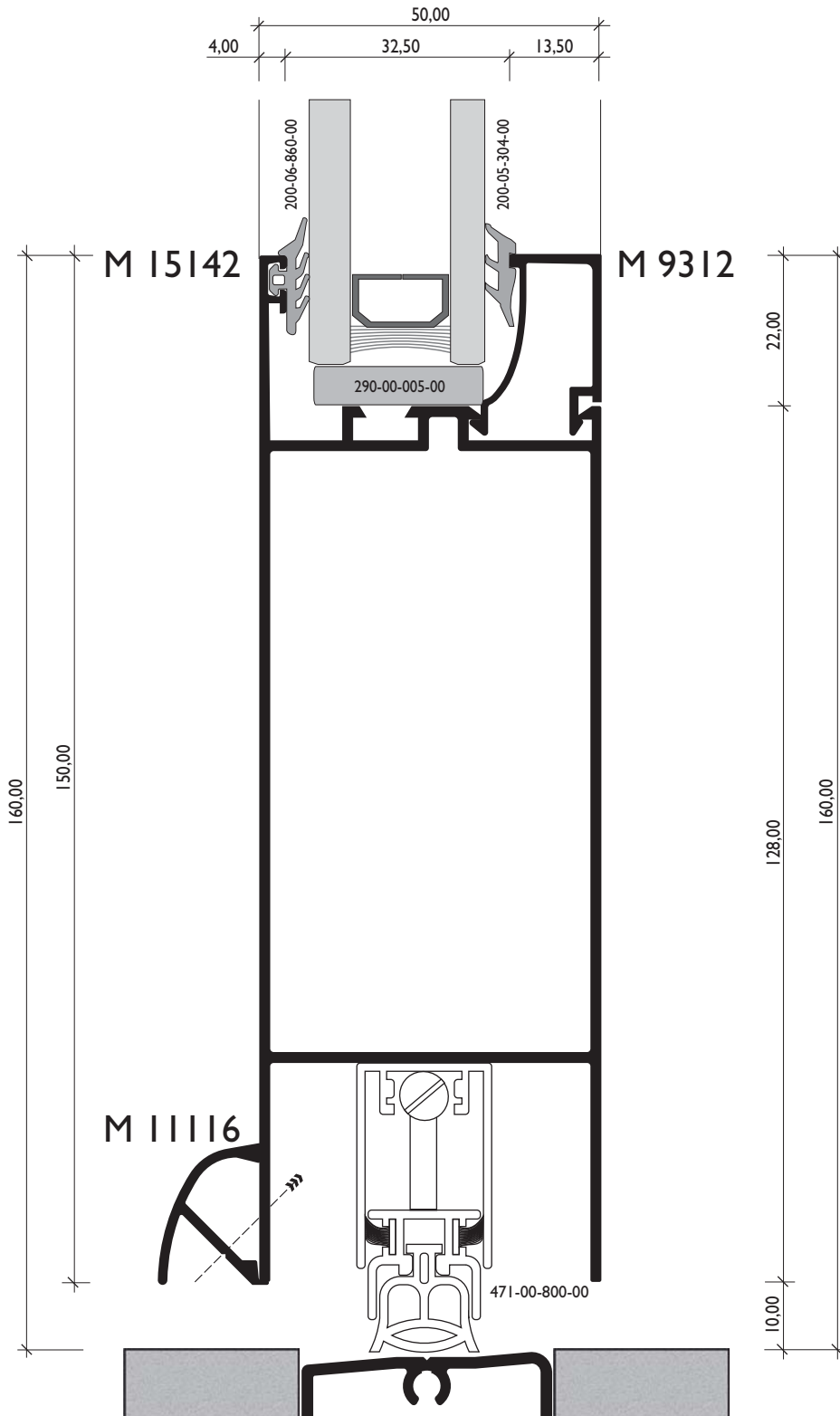

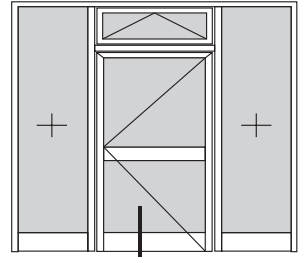

118.

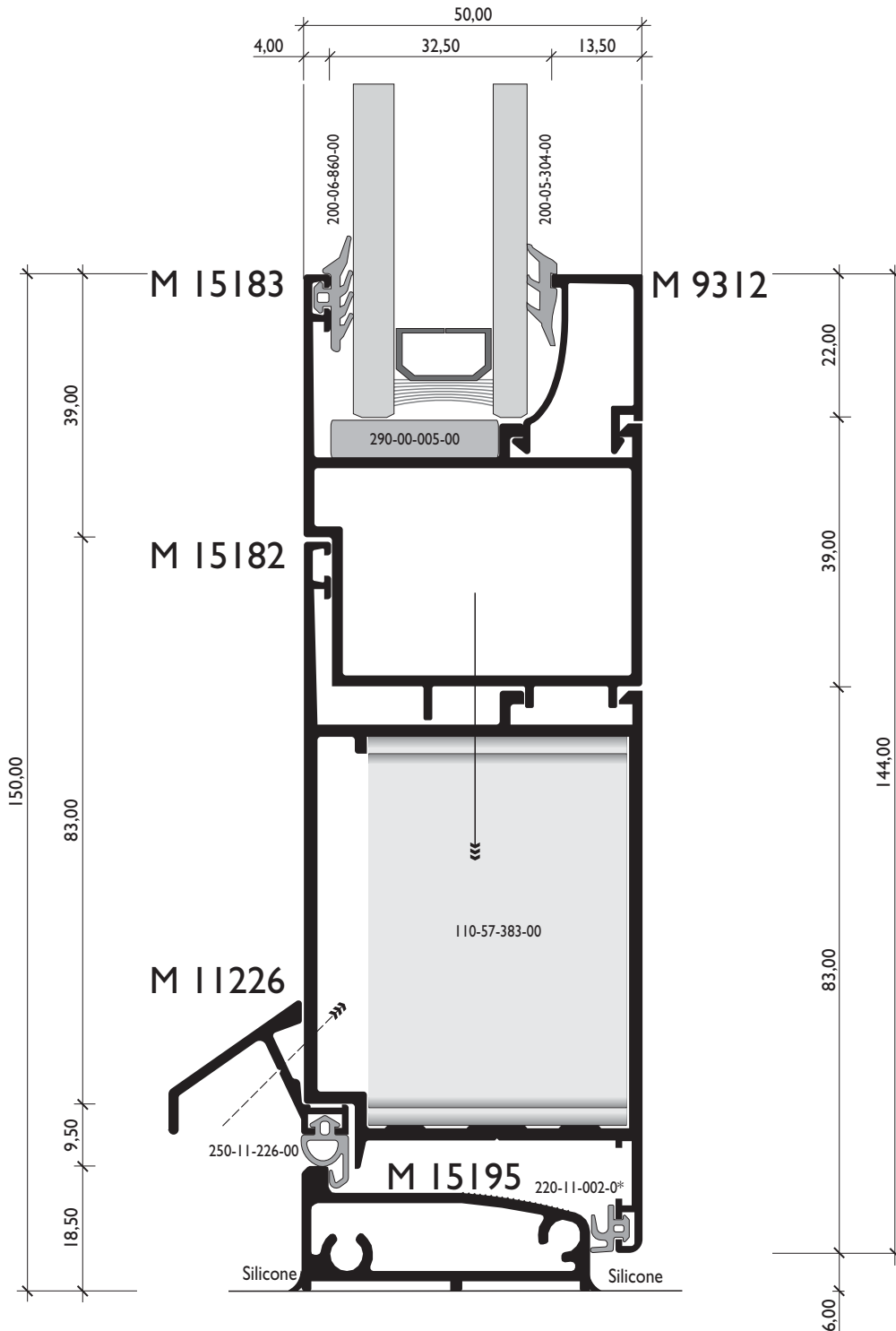

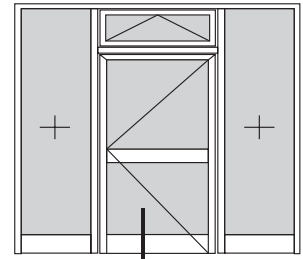

19.

